

**Pioneer**

Blu-ray Disc PLAYER

# **BDP-V6000**

Operating Instructions



Thank you for buying this Pioneer product.

Please read through these operating instructions so you will know how to operate your model properly. After you have finished reading the instructions, put them away in a safe place for future reference.

## IMPORTANT



The lightning flash with arrowhead symbol, within an equilateral triangle, is intended to alert the user to the presence of uninsulated "dangerous voltage" within the product's enclosure that may be of sufficient magnitude to constitute a risk of electric shock to persons.

### CAUTION

**RISK OF ELECTRIC SHOCK  
DO NOT OPEN**

#### CAUTION:

TO PREVENT THE RISK OF ELECTRIC SHOCK, DO NOT REMOVE COVER (OR BACK). NO USER SERVICEABLE PARTS INSIDE. REFER SERVICING TO QUALIFIED SERVICE PERSONNEL.



The exclamation point within an equilateral triangle is intended to alert the user to the presence of important operating and maintenance (servicing) instructions in the literature accompanying the appliance.

D3-4-2-1-1\_A1\_En

## IMPORTANT NOTICE

THE SERIAL NUMBER FOR THIS EQUIPMENT IS LOCATED IN THE REAR. PLEASE WRITE THIS SERIAL NUMBER ON YOUR ENCLOSED WARRANTY CARD AND KEEP IN A SECURE AREA. THIS IS FOR YOUR SECURITY.

D1-4-2-6-1\*\_A1\_En

## NOTE:

This equipment has been tested and found to comply with the limits for a Class B digital device, pursuant to Part 15 of the FCC Rules. These limits are designed to provide reasonable protection against harmful interference in a residential installation. This equipment generates, uses, and can radiate radio frequency energy and, if not installed and used in accordance with the instructions, may cause harmful interference to radio communications. However, there is no guarantee that interference will not occur in a particular installation. If this equipment does cause harmful interference to radio or television reception, which can be determined by turning the equipment off and on, the user is encouraged to try to correct the interference by one or more of the following measures:

Reorient or relocate the receiving antenna.

Increase the separation between the equipment and receiver.

Connect the equipment into an outlet on a circuit different from that to which the receiver is connected.

Consult the dealer or an experienced radio/TV technician for help.

D8-10-1-2\_A1\_En

## Information to User

Alterations or modifications carried out without appropriate authorization may invalidate the user's right to operate the equipment.

D8-10-2\_A1\_En

## CAUTION

This product satisfies FCC regulations when shielded cables and connectors are used to connect the unit to other equipment. To prevent electromagnetic interference with electric appliances such as radios and televisions, use shielded cables and connectors for connections.

D8-10-3a\_A1\_En

**CAUTION :** USE OF CONTROLS OR ADJUSTMENTS OR PERFORMANCE OF PROCEDURES OTHER THAN THOSE SPECIFIED HEREIN MAY RESULT IN HAZARDOUS RADIATION EXPOSURE.

**CAUTION :** THE USE OF OPTICAL INSTRUMENTS WITH THIS PRODUCT WILL INCREASE EYE HAZARD. D6-8-2-1\_En

This Class B digital apparatus complies with Canadian ICES 003.

D8-10-1-3\_A1\_En

## WARNING

**To prevent a fire hazard, do not place any naked flame sources (such as a lighted candle) on the equipment.**

D3-4-2-1-7a\_A\_En

# IMPORTANT SAFETY INSTRUCTIONS

- 1) Read these instructions.
- 2) Keep these instructions.
- 3) Heed all warnings.
- 4) Follow all instructions.
- 5) Do not use this apparatus near water.
- 6) Clean only with dry cloth.
- 7) Do not block any ventilation openings. Install in accordance with the manufacturer's instructions.
- 8) Do not install near any heat sources such as radiators, heat registers, stoves, or other apparatus (including amplifiers) that produce heat.
- 9) Do not defeat the safety purpose of the polarized or grounding-type plug. A polarized plug has two blades with one wider than the other. A grounding type plug has two blades and a third grounding prong. The wide blade or the third prong are provided for your safety. If the provided plug does not fit into your outlet, consult an electrician for replacement of the obsolete outlet.
- 10) Protect the power cord from being walked on or pinched particularly at plugs, convenience receptacles, and the point where they exit from the apparatus.
- 11) Only use attachments/accessories specified by the manufacturer.
- 12) Use only with the cart, stand, tripod, bracket, or table specified by the manufacturer, or sold with the apparatus. When a cart is used, use caution when moving the cart/apparatus combination to avoid injury from tip-over.
- 13) Unplug this apparatus during lightning storms or when unused for long periods of time.
- 14) Refer all servicing to qualified service personnel. Servicing is required when the apparatus has been damaged in any way, such as power-supply cord or plug is damaged, liquid has been spilled or objects have fallen into the apparatus, the apparatus has been exposed to rain or moisture, does not operate normally, or has been dropped.



P1-4-2-2\_En

## CAUTION

This product is a class 1 laser product, but this product contains a laser diode higher than Class 1. To ensure continued safety, do not remove any covers or attempt to gain access to the inside of the product. Refer all servicing to qualified personnel. The following caution label appears on your unit. Location: inside of the unit

CLASS 1  
LASER PRODUCT

<b>CAUTION</b>	CLASS 3B VISIBLE AND INVISIBLE LASER RADIATION WHEN OPEN, AVOID EXPOSURE TO THE BEAM.
<b>ATTENTION</b>	RADIATIONS LASER VISIBLES ET INVISIBLES DE CLASSE 3B QUAND OUVERT. ÉVITEZ TOUT EXPOSITION AU FAISCEAU.
<b>ADVARSEL</b>	KLASSE 3B SYNLIG OG USYNLIG LASERSTRÅLING VED ÅBNING. UNDGÅ UDSÆTTELSE FOR STRÅLING.
<b>VARNING</b>	KLASS 3B SYNLIG OCH OSYNLIG LASERSTRÅLNING NÄR DENNA DEL ÄR ÖPPNAD. UNDVÄJ ATT UTSÄTTA DIG FÖR STRÅLEN.
<b>VORSICHT</b>	BEI GEFÖHNER ABDECKUNG IST SICHTBARE UND UNSICHTBARE LASERSTRÄHLUNG DER KLASSE 3B IM GERÄTENEBENEN VORHANDEN. NICHT DEN LASERSTRÄHL. AUSSETZEN!
<b>PRECAUCIÓN</b>	CUANDO SE ABRE HAY RADIACIÓN LÁSER DE CLASE 3B VISIBLE E INVISIBLE. EVITE LA EXPOSICIÓN A LOS RAYOS LÁSER.
<b>VARO!</b>	AVATTAESSA OLET ALTTIINA NÄKYVÄLLE JA NÄKYMÄTTÖMÄLLE LUOKAN 3B LASERSÄTELYLLE. ÄLÄ KATSO SÄTEESEEN.
<b>注意</b>	打開時會有CLASS 3B可見和不可見鐳射輻射・請勿受鐳射束輻射。
<b>注意</b>	ここを前くとCLASS 3Bの可視レーザー光及び不可視レーザー光が出ます。ビームを直接見たり、触れたりしないこと。

D3-4-2-1-8\*\_C\_En

## WARNING

This equipment is not waterproof. To prevent a fire or shock hazard, do not place any container filled with liquid near this equipment (such as a vase or flower pot) or expose it to dripping, splashing, rain or moisture.

D3-4-2-1-3\_B\_En

## Operating Environment

Operating environment temperature and humidity: +5 °C to +35 °C (+41 °F to +95 °F); less than 85 %RH (cooling vents not blocked)

Do not install this unit in a poorly ventilated area, or in locations exposed to high humidity or direct sunlight (or strong artificial light)

D3-4-2-1-7c\*\_A1\_En

## WARNING

Before plugging in for the first time, read the following section carefully.

The voltage of the available power supply differs according to country or region. Be sure that the power supply voltage of the area where this unit will be used meets the required voltage (e.g., 230 V or 120 V) written on the rear panel.

D3-4-2-1-4\_A\_En

If the AC plug of this unit does not match the AC outlet you want to use, the plug must be removed and appropriate one fitted. Replacement and mounting of an AC plug on the power supply cord of this unit should be performed only by qualified service personnel. If connected to an AC outlet, the cut off plug can cause severe electrical shock. Make sure it is properly disposed of after removal. The equipment should be disconnected by removing the mains plug from the wall socket when left unused for a long period of time (for example, when on vacation).

D3-4-2-1a\_A1\_En

#### CAUTION

The  STANDBY/ON switch on this unit will not completely shut off all power from the AC outlet. Since the power cord serves as the main disconnect device for the unit, you will need to unplug it from the AC outlet to shut down all power. Therefore, make sure the unit has been installed so that the power cord can be easily unplugged from the AC outlet in case of an accident. To avoid fire hazard, the power cord should also be unplugged from the AC outlet when left unused for a long period of time (for example, when on vacation).

D3-4-2-2a\_A\_En

**WARNING:** Handling the cord on this product or cords associated with accessories sold with the product will expose you to chemicals listed on proposition 65 known to the State of California and other governmental entities to cause cancer and birth defect or other reproductive harm.

***Wash hands after handling***

D36-P4\_A\_En

This product contains mercury. Disposal of this material may be regulated due to environmental considerations. For disposal or recycling information, please contact your local authorities or the Electronics Industries Alliance : [www.eiae.org](http://www.eiae.org).

K057\_En

#### FEDERAL COMMUNICATIONS COMMISSION DECLARATION OF CONFORMITY

This device complies with part 15 of the FCC Rules. Operation is subject to the following two conditions: (1) This device may not cause harmful interference, and (2) this device must accept any interference received, including interference that may cause undesired operation.

Product Name: Blu-ray Disc PLAYER

Model Number: BDP-V6000

Responsible Party Name: PIONEER ELECTRONICS (USA), INC.  
SERVICE SUPPORT DIVISION

Address: 1925 E. DOMINGUEZ ST. LONG BEACH, CA 90810-1003, U.S.A.

Phone: 1-800-421-1404

URL: <http://www.pioneerelectronics.com>

D8-10-4\*\_B1\_En

#### POWER-CORD CAUTION

Handle the power cord by the plug. Do not pull out the plug by tugging the cord and never touch the power cord when your hands are wet as this could cause a short circuit or electric shock. Do not place the unit, a piece of furniture, etc., on the power cord, or pinch the cord. Never make a knot in the cord or tie it with other cords. The power cords should be routed such that they are not likely to be stepped on. A damaged power cord can cause a fire or give you an electrical shock. Check the power cord once in a while. If you find it damaged, contact the Pioneer service center on the back cover, or your dealer for a replacement.

This product incorporates copyright protection technology that is protected by method claims of certain U.S. patents and other intellectual property rights owned by Macrovision Corporation and other rights owners. Use of this copyright protection technology must be authorized by Macrovision Corporation, and is intended for home and other limited viewing uses only unless otherwise authorized by Macrovision Corporation. Reverse engineering or disassembly is prohibited.



## Dear Customer:

Selecting fine audio equipment such as the unit you've just purchased is only the start of your musical enjoyment. Now it's time to consider how you can maximize the fun and excitement your equipment offers. This manufacturer and the Electronic Industries Association's Consumer Electronics Group want you to get the most out of your equipment by playing it at a safe level. One that lets the sound come through loud and clear without annoying blaring or distortion-and, most importantly, without affecting your sensitive hearing.

Sound can be deceiving. Over time your hearing "comfort level" adapts to higher volumes of sound. So what sounds "normal" can actually be loud and harmful to your hearing. Guard against this by setting your equipment at a safe level BEFORE your hearing adapts.

### To establish a safe level:

- Start your volume control at a low setting.
- Slowly increase the sound until you can hear it comfortably and clearly, and without distortion.

### Once you have established a comfortable sound level:

- Set the dial and leave it there.

Taking a minute to do this now will help to prevent hearing damage or loss in the future. After all, we want you listening for a lifetime.

## We Want You Listening For A Lifetime

Since hearing damage from loud noise is often undetectable until it is too late, this manufacturer and the Electronic Industries Association's Consumer Electronics Group recommend you avoid prolonged exposure to excessive noise. This list of sound levels is included for your protection.

### Decibel Level Example

30	Quiet library, soft whispers
40	Living room, refrigerator, bedroom away from traffic
50	Light traffic, normal conversation, quiet office
60	Air conditioner at 20 feet, sewing machine
70	Vacuum cleaner, hair dryer, noisy restaurant
80	Average city traffic, garbage disposals, alarm clock at two feet.

### THE FOLLOWING NOISES CAN BE DANGEROUS UNDER CONSTANT EXPOSURE

90	Subway, motorcycle, truck traffic, lawn mower
100	Garbage truck, chain saw, pneumatic drill
120	Rock band concert in front of speakers, thunderclap
140	Gunshot blast, jet plane
180	Rocket launching pad

Information courtesy of the Deafness Research Foundation.



5001\_En

# Contents

## 01 Before you start

What's in the box . . . . .	7
Putting the batteries in the remote control . . . . .	7
Software updating . . . . .	7
Types of discs/files that can be played . . . . .	8
Playable discs . . . . .	8
Playable files . . . . .	10
Part Names and Functions . . . . .	11
Remote Control . . . . .	11
Front Panel . . . . .	12
Front Panel Display . . . . .	13
Rear Panel . . . . .	13

## 02 Installation

Cautions on use . . . . .	14
Cautions on Installation . . . . .	14
Place of installation . . . . .	14
Moving the player . . . . .	15
Turn the power off when not using the player . . . . .	15
Condensation . . . . .	15
Cleaning the player . . . . .	15
Caution for when the unit is installed in a rack with a glass door . . . . .	15
Cleaning the pickup lens . . . . .	15
Handling discs . . . . .	15
Installation Procedure . . . . .	16

## 03 Connecting up

Connecting using an HDMI cable . . . . .	18
About HDMI . . . . .	18
About KURO LINK function . . . . .	19
Connecting a TV . . . . .	20
Connecting an AV receiver or amplifier . . . . .	20
Connecting video and audio cables . . . . .	21
Connecting a TV using a video/audio cable . . . . .	21
Connecting an AV receiver or amplifier using audio cables . . . . .	21
Connecting components to the USB port . . . . .	21
About USB (external storage) devices . . . . .	21
Connecting the USB (external storage) device . . . . .	22
Network connection . . . . .	22
Connecting via an Ethernet hub . . . . .	22
Connecting the power cord . . . . .	22

## 04 Getting Started

Making settings using the Setup Navigator menu . . . . .	23
Operating the TV with the player's remote control . . . . .	24
TV Preset code list . . . . .	25
Using the TOOLS menu . . . . .	26
Switching the video output terminal to be viewed . . . . .	26
Switching the output video resolution . . . . .	27

## 05 Playback

Playing discs or files . . . . .	29
Forward and reverse scanning . . . . .	30
Playing specific titles, chapters or tracks . . . . .	30
Skipping content . . . . .	30
Playing in slow motion . . . . .	30
Step forward and step reverse . . . . .	30
Switching the camera angles . . . . .	30
Switching the subtitles . . . . .	30
Switching the audio and secondary audio . . . . .	31

Switching the secondary video . . . . .	31
Displaying the disc information . . . . .	31
Playback functions . . . . .	32
Using the Play Mode functions . . . . .	33
Playing from a specific time (Time Search) . . . . .	33
Playing a specific title, chapter or track (Search) . . . . .	33
Playing a specific section within a title or track repeatedly (A-B Repeat) . . . . .	33
Playing repeatedly (Repeat Play) . . . . .	34
Playing in random order (Random Play) . . . . .	34
About Play Mode types . . . . .	35
Playing from the Home Media Gallery . . . . .	36
Playing discs . . . . .	36
Playing image files . . . . .	36
Playing audio files . . . . .	37
Playing in the desired order (HMG Playlist) . . . . .	37

## 06 Adjusting audio and video

Adjusting the video . . . . .	39
Adjusting the audio . . . . .	40
Adjusting the Audio DRC . . . . .	40
Adjusting the output level of the different speakers during BD/DVD playback (Channel Level) . . . . .	40
Adjusting the audio delay (Lip Sync) . . . . .	41

## 07 Detailed settings

Changing the settings . . . . .	42
Operating the Initial Setup screen . . . . .	42
Software updating . . . . .	51
Restoring all the settings to the factory default settings . . . . .	51
About the audio output settings . . . . .	52
Language Code Table and Country/Area Code Table . . . . .	54

## 08 Advanced setup

Changing the settings . . . . .	55
Operating the Advanced Setup screen . . . . .	55
Playing titles/chapters in the registered order (Playlist) . . . . .	56
Creating playlist . . . . .	56
Playing the playlist . . . . .	57

## 09 Additional information

Serial interface specifications . . . . .	58
Serial control specifications . . . . .	58
Connection to a computer . . . . .	58
Commands and statuses . . . . .	59
List of usable commands . . . . .	59
Command mnemonics . . . . .	60
Arguments . . . . .	60
Communications interface manual . . . . .	60
Licenses . . . . .	61
Troubleshooting . . . . .	67
Playback . . . . .	67
KURO LINK . . . . .	70
Network . . . . .	71
Others . . . . .	72
Glossary . . . . .	73
Specifications . . . . .	75

## What's in the box

- Remote control x 1
- Video/audio cable (yellow/white/red plugs) x 1
- AA/R6 dry cell batteries x 2
- Power cord x 1
- Rack mount bracket x 2
- Underplate x 1
- Included gray screw x 2
- Warranty card
- Operating instructions (this document)

A large Phillips screwdriver (⊕ No. 2) is required to mount the rack mount bracket. Please procure one.

## Putting the batteries in the remote control

### 1 Open the rear cover.

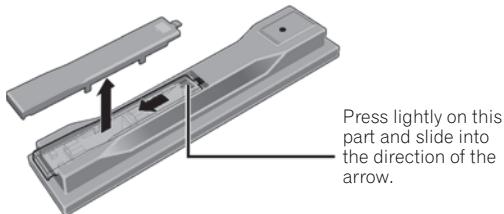

### 2 Insert the batteries (AA/R6 x 2).

Insert as indicated by the ⊕/⊖ marks into the battery compartment.

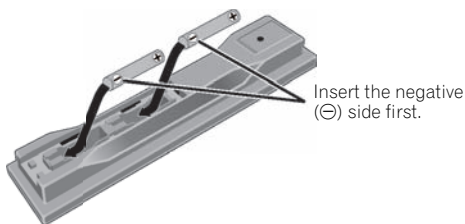

### 3 Close the rear cover.

Close securely (a click should be heard).

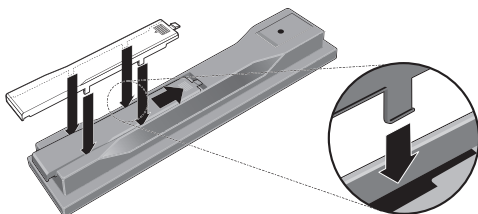

### ⚠ Caution

- Do not use any batteries other than the ones specified. Also, do not use a new battery together with an old one.
- When loading the batteries into the remote control, set them in the proper direction, as indicated by the polarity marks (⊕ and ⊖).
- Do not heat batteries, disassemble them, or throw them into flames or water.
- Batteries may have different voltages, even if they look similar. Do not use different kinds of batteries together.
- To prevent leakage of battery fluid, remove the batteries if you do not plan to use the remote control for a long period of time (1 month or more). If the fluid should leak, wipe it carefully off the inside of the case, then insert new batteries. If a battery should leak and the fluid should get on your skin, flush it off with large quantities of water.
- When disposing of used batteries, please comply with governmental regulations or environmental public institution's rules that apply in your country/area.

### • WARNING

Do not use or store batteries in direct sunlight or other excessively hot place, such as inside a car or near a heater. This can cause batteries to leak, overheat, explode or catch fire. It can also reduce the life or performance of batteries.

D3-4-2-3-3\_En

## Software updating

When the software is updated, product information concerning this product may be made public on the Pioneer website. Check the update or service information concerning this product.

# Types of discs/files that can be played

## Playable discs

Discs with the logo marks below indicated on the disc label, package or jacket can be played.

Disc type	Logo	Application format					
		BDMV <sup>1</sup>	BDAV	DVD-Video	DVD VR	CD-DA DTS-CD	DATA-DISC <sup>2</sup>
BD <sup>3</sup>	BD-ROM	✓	✓	X	X	X	X
	BD-R	✓ <sup>4</sup>	✓	X	X	X	X
	BD-RE	✓	✓	X	X	X	X
DVD	DVD-ROM	✓	X	✓	X	X	✓
	DVD-R <sup>3,4,5</sup>	✓	X	✓	✓	X	✓
	DVD-RW <sup>4,6</sup>	✓	X	✓	✓	X	✓
	DVD+R <sup>3,4</sup>	✓	X	✓	X	X	✓
	DVD+RW <sup>4</sup>	✓	X	✓	X	X	✓
	CD (Audio CD)	X	X	X	X	✓	X
CD	CD-R <sup>4</sup>	X	X	X	X	✓	✓
	CD-RW <sup>4</sup>	X	X	X	X	✓	✓
	CD-ROM	X	X	X	X	✓	✓

1. Including the AVCHD format.
2. Discs on which image or audio files are recorded.
3. Including dual-layered discs.
4. Finalize (close) them before playing them on this player.
5. DVD-R for Authoring discs (3.95 and 4.7 GB) cannot be played.
6. Version 1.0 DVD-RW discs cannot be played.

"Blu-ray Disc" and  are trademarks.

 is a trademark of DVD Format/Logo Licensing Corporation.



## ❖ Discs that cannot be played

- HD DVDs
- DVD Audio discs
- DVD-RAM discs
- SACDs
- Video CDs
- SVCDs

It is possible that some discs other than the ones listed above may not be playable either.



### Note

- Some discs cannot be played, even if one of the logo marks on the previous page is indicated.
- To play 8 cm discs, set the disc in the 8 cm disc depression in the center of the disc tray. No adapter is necessary. 8 cm BD-ROMs cannot be played.

## ❖ About playback of unauthorized copies

### Cinavia Notice

This product uses Cinavia technology to limit the use of unauthorized copies of some commercially-produced film and videos and their soundtracks. When a prohibited use of an unauthorized copy is detected, a message will be displayed and playback or copying will be interrupted. More information about Cinavia technology is provided at the Cinavia Online Consumer Information Center at <http://www.cinavia.com>. To request additional information about Cinavia by mail, send a postcard with your mailing address to: Cinavia Consumer Information Center, P.O. Box 86851, San Diego, CA, 92138, USA.

*Copyright 2004-2009 Verance Corporation. Cinavia™ is a Verance Corporation trademark. Protected by U.S. Patent 7,369,677 and worldwide patents issued and pending under license from Verance Corporation. All rights reserved.*

## ❖ About audio formats

The following audio formats are supported on this player:

- Dolby TrueHD
- Dolby Digital Plus
- Dolby Digital
- DTS-HD Master Audio
- DTS-HD High Resolution Audio
- DTS Digital Surround
- MPEG
- MPEG-2 AAC
- Linear PCM

To enjoy the surround sound of Dolby TrueHD, Dolby Digital Plus, DTS-HD Master Audio and DTS-HD High Resolution Audio, it is recommended to connect the player to an AV receiver or amplifier compatible with these audio formats using an HDMI cable. After loading a BD containing sound in one of these audio formats, select the audio format on the menu screen.

See *About the audio output settings* on page 52 for the output conditions of the different formats.

*Manufactured under license from Dolby Laboratories. Dolby and the double-D symbol are trademarks of Dolby Laboratories.*

*Manufactured under license under U.S. Patent #'s: 5,451,942; 5,956,674; 5,974,380; 5,978,762; 6,226,616; 6,487,535; 7,392,195; 7,272,567; 7,333,929; 7,212,872 & other U.S. and worldwide patents issued & pending. DTS is a registered trademark and the DTS logos, Symbol, DTS-HD and DTS-HD Master Audio | Essential are trademarks of DTS, Inc. © 1996-2008 DTS, Inc. All Rights Reserved.*

## ❖ Playing BDs

- BDs (BDMV) compatible with the formats below can be played.
  - Blu-ray Disc Read-Only (ROM) Format Version 2
  - Blu-ray Disc Recordable (R) Format Version 2
  - Blu-ray Disc Rewritable (RE) Format Version 3

This player supports BD-ROM Profile 2.

BONUSVIEW functions such as playback of secondary video (Picture-in-Picture) and secondary audio can be used. The data used with the BONUSVIEW functions (the secondary video (Picture-in-Picture) and secondary audio data) may be stored in the storage. For details on secondary video and secondary audio playback, refer to the disc's instructions.

## BONUSVIEW™

*"BONUSVIEW" is trademark of Blu-ray Disc Association.*

BD-LIVE functions such as downloading movie trailers or additional audio and subtitle languages and playing on-line games can be enjoyed over the Internet. The data downloaded with the BD-LIVE function (trailers, etc.) is stored in the storage. Refer to the disc's instructions for details about BD-LIVE functions.



*"BD-LIVE" logo is trademark of Blu-ray Disc Association.*

With BD-ROMs, it is possible to use BD-J (Java) applications to create highly interactive titles, for example including games.



*Java and all Java-based trademarks and logos are trademarks or registered trademarks of Sun Microsystems, Inc. in the U.S. and other countries.*

The player's internal storage has a maximum capacity of roughly 1 GB. Use an external storage connected to the **USB** port if you want to store large quantities of data (page 21). If a message saying there is not enough storage space appears, erase any unnecessary data (page 49).

- BDs (BD-RE) compatible with the formats below can be played.
  - Blu-ray Disc Recordable (R) Format Version 1
  - Blu-ray Disc Rewritable (RE) Format Version 2

## ❖ Playing DVDs



*This label indicates playback compatibility with DVD-RW discs recorded in VR format (Video Recording format). However, for discs recorded with a record-only-once encrypted program, playback can only be achieved using a CPRM compatible device.*

The AVCHD is a high definition (HD) digital video camera recorder format recording high-definition onto certain media by using highly efficient codec technologies.



*"AVCHD" and the "AVCHD" logo are trademarks of Panasonic Corporation and Sony Corporation.*

## ❖ About region numbers

Blu-ray Disc Player and BD-ROM or DVD-Video discs are assigned region numbers according to the region in which they are sold.

This player's region numbers are:

- BD-ROM: A
- DVD-Video: 1

Discs not including these numbers cannot be played. Discs playable on this player are as shown below.

- BDs: A (including A) and ALL
- DVDs: 1 (including 1) and ALL

## ❖ Playing CDs

Regarding copy protected CDs: This player is designed to conform to the specifications of the Audio CD format. This player does not support the playback or function of discs that do not conform to these specifications.

## ❖ DualDisc playback

A DualDisc is a new two-sided disc, one side of which contains DVD content — video, audio, etc. — while the other side contains non-DVD content such as digital audio material.

The DVD side of a DualDisc can be played on this player (excluding any DVD-Audio content).

The non-DVD, audio side of the disc is not compatible with this player.

It is possible that when loading or ejecting a DualDisc, the opposite side to that being played will be scratched. Scratched discs may not be playable.

For more detailed information on the DualDisc specification, please refer to the disc manufacturer or disc retailer.

## ❖ Playing discs created on computers or BD/DVD recorders

- It may not be possible to play discs recorded using a computer due to the application settings or computer's environment settings. Record discs in a format playable on this player. For details, contact the dealer.
- It may not be possible to play discs recorded using a computer or a BD/DVD recorder, if burn quality is not good due to characteristics of the disc, scratches, dirt on the disc, dirt on the recorder's lens, etc.

## Playable files

Image and audio files recorded on DVDs and CDs can be played.

### ⚠ Caution

- In DVD, only the one recorded by the ISO 9660 file system can be played.
- Some files may not be playable.
- For some files, it may not be possible to use certain functions during playback.
- It may not be possible to play some files, even if they have the extension of a file playable on this player.
- Files protected by DRM (Digital Rights Management) cannot be played.

## ❖ Supported image file formats

- **JPEG**  
File format: JFIF Ver. 1.02/Exif Ver. 2.2  
Resolution: Up to 4096 x 4096 pixels  
Only baseline JPEG files are supported.

## ❖ Supported audio file formats

### • Windows Media™ Audio 9 (WMA9)

Bit rate: Up to 192 kbps  
Sampling frequencies: 22.05 kHz, 32 kHz, 44.1 kHz and 48 kHz

*Windows Media is either a registered trademark or trademark of Microsoft Corporation in the United States and/or other countries.*

*This product includes technology owned by Microsoft Corporation and cannot be used or distributed without a license from Microsoft Licensing, Inc.*

### • MPEG-1 Audio Layer 3 (MP3)

Bit rate: Up to 320 kbps  
Sampling frequencies: 8 kHz, 11.025 kHz, 12 kHz, 16 kHz, 22.05 kHz, 24 kHz, 32 kHz, 44.1 kHz and 48 kHz

## ❖ Playable file extensions

### • Image files

.jpg and .jpeg

### • Audio files

.wma and .mp3

# Part Names and Functions

## Remote Control

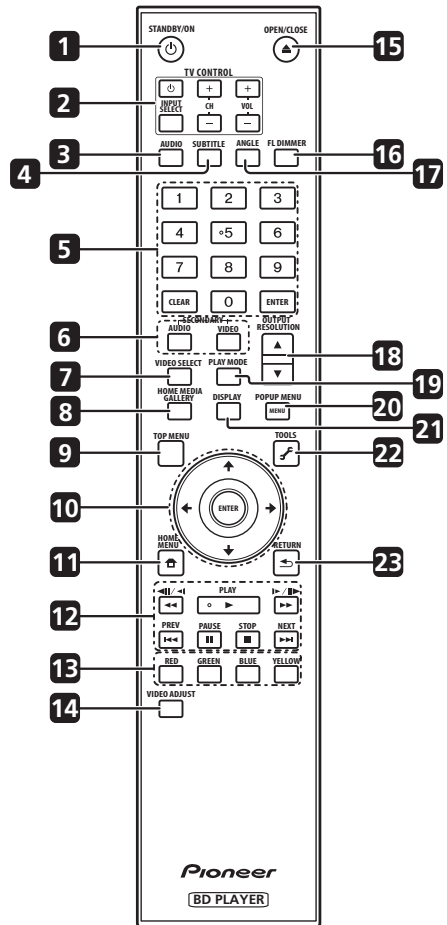

- 1 **⏻ STANDBY/ON** – Press to turn the power on and off.
- 2 **TV CONTROL** – (page 24)
- 3 **AUDIO** – (page 31)
- 4 **SUBTITLE** – (page 30)
- 5 **Number buttons** – Use these to select and play the title/chapter/track you want to view or listen to and to select items from menus.  
**CLEAR** – Press to clear the numeric number, etc.  
**ENTER** – Press to execute the selected item or enter a setting that has been changed, etc.
- 6 **SECONDARY AUDIO** – (page 31)  
**SECONDARY VIDEO** – (page 31)

- 7 VIDEO SELECT** – (page 26)
- 8 HOME MEDIA GALLERY** – (page 36)
- 9 TOP MENU** – Press to display the top menu of the BD-ROM or DVD-Video.
- 10** **↑/↓/←/→** – Use to select items, change settings and move the cursor.  
**ENTER** – Press to execute the selected item or enter a setting that has been changed, etc.
- 11** **🏠 HOME MENU** – (page 42)
- 12** **▶ PLAY** – (page 29)  
**⏸ PAUSE** – (page 29)  
**■ STOP** – (page 29)  
**⏮ PREV/▶▶ NEXT** – (page 30)  
**⏪/⏩/⏹** – (page 30)  
**▶/⏸/▶▶** – (page 30)
- 13 RED/GREEN/BLUE/YELLOW** – Use these to navigate BD-ROM menus.
- 14 VIDEO ADJUST** – (page 39)
- 15** **▲ OPEN/CLOSE** – Press to open and close the disc tray.

- 16 FL DIMMER** – When pressed, the brightness of the player's front panel display and the status of the indicators on the player's front panel changes.

Front panel display	Indicators		
	Blu-ray	FL OFF	HDMI <sup>1</sup>
Bright	Bright	Off	Lit
Medium	Bright	Off	Lit
Dark	Dark	Off	Lit
Off	Off	Lit	Off

1. This lights when an HDMI-compatible device is connected to an **HDMI OUT** terminal (page 18).

- 17 ANGLE** – (page 30)
- 18 OUTPUT RESOLUTION** – (page 27)
- 19 PLAY MODE** – (page 33)
- 20 POP UP MENU/MENU** – Press to display the BD-ROM or DVD-Video menus.
- 21 DISPLAY** – (page 31)
- 22** **🔧 TOOLS** – (page 26)
- 23** **↶ RETURN** – Press to return to the previous screen.

## Front Panel

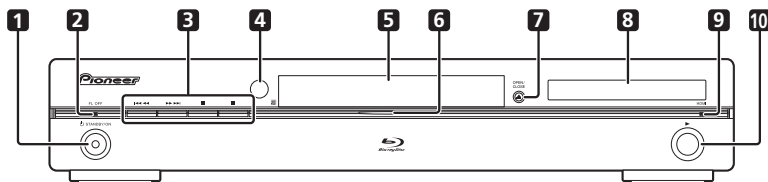

- 1** **⏻ STANDBY/ON** – Press to turn the power on and off.
- 2** **FL OFF indicator** – Lights when the player's front panel display is turned off pressing **FL DIMMER**.
- 3** **⏮/⏪** – Press to skip to the beginning of the previous title/chapter/track/file. Press and hold to start reverse scanning (page 30).  
**▶▶/▶** – Press to skip to the beginning of the next title/chapter/track/file. Press and hold to start forward scanning (page 30).  
**⏸** – Press during playback to pause. Press again to restart playback.  
**■** – Press to stop playback.
- 4** **Remote control sensor** – Point the remote control to this, then operate it within approximately 23 feet (7 m).  
The player may have trouble capturing remote control signals if there is a fluorescent light nearby. If this happens, move the player away from the fluorescent light.
- 5** **Disc tray**
- 6** **Blu-ray indicator** – Lights when the power is turned on.
- 7** **▲ OPEN/CLOSE** – Press to open and close the disc tray.
- 8** **Front panel display**
- 9** **HDMI indicator** – (page 18)
- 10** **▶** – Press to start playback.

## Front Panel Display

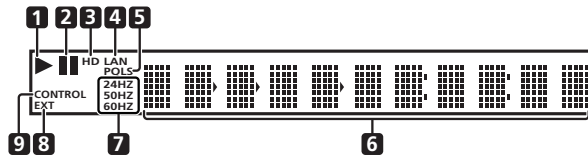

- |   |  |
|---|--|
| <p>1 ► – (page 29)</p> <p>2    – (page 29)</p> <p>3 <b>HD</b> – This lights when an HDMI cable is connected and video signals are being output with a resolution of 1080/60i, 1080/60p, 720/60p, 1080/50i, 1080/50p, 720/50p or 1080/24p. It also lights when a component video cable is connected and video signals are being output with a resolution of 1080/60i or 720/60p.</p> | <p>4 <b>LAN</b> – (page 22)</p> <p>5 <b>PQLS</b> – (page 19)</p> <p>6 <b>Character display</b> – Displays the title/chapter/track number, elapsed time, etc.</p> <p>7 <b>24HZ/50HZ/60HZ</b> – The frequency of the video frame or field being output lights.</p> <p>8 <b>EXT</b> – (page 21)</p> <p>9 <b>CONTROL</b> – (page 19)</p> |
|---|--|

## Rear Panel

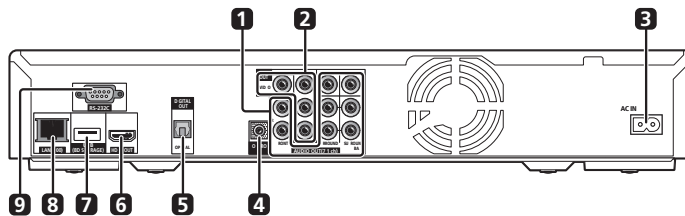

- |  |   |
|--|---|
| <p>1 <b>AUDIO OUT (7.1 ch) terminals</b> – (page 21)</p> <p>2 <b>VIDEO OUT terminals</b><br/> <b>VIDEO</b> – (page 21)<br/> <b>COMPONENT VIDEO</b> – (page 21)</p> <p>3 <b>AC IN</b> – (page 22)</p> <p>4 <b>CONTROL IN terminal</b> – Use to control this player from the remote sensor of another Pioneer component with a <b>CONTROL OUT</b> terminal and bearing the  mark. Connect the <b>CONTROL OUT</b> terminal of the other component to <b>CONTROL IN</b> on this player using a mini-plug cord (commercially available).</p> | <p>5 <b>DIGITAL OUT (OPTICAL) terminal</b> – (page 21)</p> <p>6 <b>HDMI OUT terminal</b> – (page 20)</p> <p>7 <b>USB (BD STORAGE) port</b> – (page 21)</p> <p>8 <b>LAN (100) terminal</b> – (page 22)</p> <p>9 <b>RS-232C terminal</b> – Serial control of the player is possible when connected to a computer (page 58).</p> |
|--|---|

### Caution

- Be sure to connect cables for outputting the audio and video signals.
- When connected via System Control, point the remote control toward the connected component (such as an AV receiver or amplifier). The remote will not work correctly when pointed at this player.
- You cannot use System Control with components that do not have a System Control terminal or with components manufactured by companies other than Pioneer.

# Installation

## Cautions on use

- Please note that Pioneer will accept no responsibility whatsoever for loss of business opportunities or other damages due to breakdown of the set.
- Please note that Pioneer will accept no responsibility whatsoever for problems resulting from the use of the set, regardless of the method of installation.
- Please note that Pioneer will accept no responsibility whatsoever for loss of data resulting from use or breakdown of the set, or for any direct or indirect damages incurred thereby.

## Cautions on Installation

Install and use the set in a level, stable place. Do not use it on shaky, unstable surfaces or places subject to strong vibrations.

The current will surge if the power to several units of the set is turned on or off simultaneously from an external device. For the value per unit, see *Specifications* on page 75.

### ⚠ Caution

- When installing the set in an EIA rack, be sure to use the included rack mount brackets. Using anything else could cause damage to the set or injury. For details on mounting, etc... see *Installation Procedure* on page 16.
- When the included rack mount brackets are used, the player can be mounted to universal pitch or wide pitch racks conforming to EIA 19" standards.

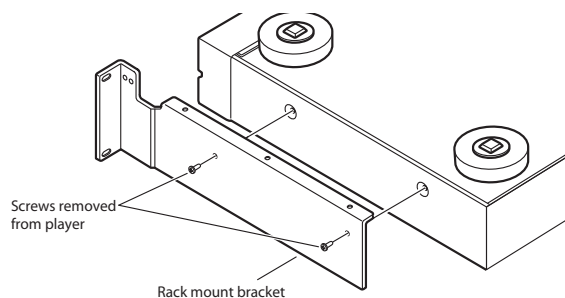

## Place of installation

Select a stable place near the TV and AV system to which the unit is connected.

Do not place the player on top of a TV or color monitor.

Keep it away from cassette decks or other components easily affected by magnetism.

Avoid the following types of places:

- Places exposed to direct sunlight or strong artificial light
- Places subject to vibration
- Places exposed to strong electromagnetic or magnetic forces
- Places in which there is much electrical noise
- Places in which electrostatic noise tends to be generated
- Humid or poorly ventilated places
- Closed racks
- Extremely hot or cold places
- Places in which there is much dust or cigarette smoke
- Places exposed to soot, steam or heat (in kitchens, etc.)

### ❖ Do not place objects on top

Do not place objects on top of the player.

### ❖ Do not obstruct the ventilation holes

Do not use the player on a shaggy rug, bed, or sofa, and do not cover the player with a cloth, etc. Doing so will prevent heat dissipation and could lead to damage.

### ❖ Keep away from heat

Do not place the player on top of an amplifier or other device generating heat. When installing in a rack, to avoid the heat generated by the amplifier and other devices, place it on a shelf below the amplifier whenever possible.

### ⚠ Caution

- When installing the player, leave a space of at least 10 cm between the player and the wall. Also, to facilitate heat radiation, leave some space between the player and other equipment. Failure to do so will cause heat to build up inside the player, leading to fire.

The player should be used within a surrounding environmental temperature of +5 to +35 °C and humidity of 85% or less (without obstructing the ventilation holes). Do not install in poorly ventilated places, places where the humidity is too high or in places exposed to direct sunlight (or strong artificial light).

## Moving the player

If you need to move this unit, first remove the disc if there's one loaded, and close the disc tray. Next, press **⏻ STANDBY/ON** to switch the power to standby, checking that the **POWER OFF** indication on the front panel display goes off. Wait at least 10 seconds. Lastly, disconnect the power cord.

Never lift or move the unit during playback — discs rotate at a high speed and may be damaged.

### ❖ Transporting the set

When transporting the set, always use the box in which it was originally packed, being sure not to drop it or subject it to vibrations or shocks.

Do not let the set be exposed to heat or water during transportation.

Be sure to remove any disc before transporting.

Transporting the set with a disc in it could scratch the disk or damage the inside of the set. Also, disconnect cables. Transporting with cables connected could damage the terminals.

## Turn the power off when not using the player

Depending on the conditions of the TV broadcast signals, striped patterns may appear on the screen when the TV is turned on while the player's power is turned on. This is not a malfunction with the player or TV. If this happens, turn the player's power off. In the same way, noise may be heard in the sound of a radio.

## Condensation

If the player is moved suddenly from a cold place into a warm room (in winter, for example) or if the temperature in the room in which the player is installed rises suddenly due to a heater, etc., water droplets (condensation) may form inside (on operating parts and the lens). When condensation is present, the player will not operate properly and playback is not possible. Let the player stand at room temperature for 1 or 2 hours with the power turned on (the time depends on the extent of condensation). The water droplets will dissipate and playback will become possible.

Condensation can also occur in the summer if the player is exposed to the direct wind from an air-conditioner. If this happens, move the player to a different place.

## Cleaning the player

Normally, wipe the player with a soft cloth. For tough dirt, apply some neutral detergent diluted in 5 to 6 parts water to a soft cloth, wring out thoroughly, wipe off the dirt, then wipe again with a dry cloth.

Note that getting alcohol, thinner, benzene or insecticide on the player could cause the print and coating to peel off. Also, avoid leaving rubber or vinyl products in contact with the player for long periods of time, as this could damage the cabinet.

When using chemical-impregnated wipes, etc., read the wipe's cautions carefully.

Unplug the power cord from the power outlet when cleaning the player.

## Caution for when the unit is installed in a rack with a glass door

Do not press the **▲ OPEN/CLOSE** on the remote control to open the disc tray while the glass door is closed. The door will hamper the movement of the disc tray, and the unit could be damaged.

## Cleaning the pickup lens

The player's lens should not become dirty in normal use, but if for some reason it should malfunction due to dust or dirt, consult your nearest Pioneer authorized service center. Although lens cleaners for players are commercially available, we advise against using them since some may damage the lens.

## Handling discs

Do not use damaged (cracked or warped) discs.

Do not scratch the disc's signal surface or let it get dirty.

Do not load more than one disc into the player at a time.

Do not glue paper or put stickers onto the disc, or use a pencil, ball-point pen or other sharp-tipped writing instrument. These could all damage the disc.



### ❖ Storing discs

Always store discs in their cases, and place the cases vertically, avoiding places exposed to high temperature or humidity, direct sunlight or extremely low temperatures.

Be sure to read the cautions included with the disc.

### ❖ Cleaning discs

It may not be possible to play the disc if there are fingerprints or dust on it. In this case, using a cleaning cloth, etc., to wipe the disc gently from the center toward the outer edge. Do not use a dirty cleaning cloth.

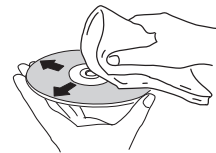

Do not use benzene, thinner or other volatile chemicals. Also do not use record spray or antistatic agents.

For tough dirt, apply some water to a soft cloth, wring out thoroughly, wipe off the dirt, then wipe off the moisture with a dry cloth.

## ❖ Specially shaped discs

Specially shaped discs (heart-shaped, hexagonal, etc.) cannot be used on this player. Never use such discs, as they will damage the player.



## ❖ Condensation on discs

If the disc is moved suddenly from a cold place into a warm room (in winter, for example), water droplets (condensation) may form on the disc surface. Discs will not play properly if there is condensation on them. Carefully wipe off the water droplets from the disc surface before using the disc.

## ❖ Extended use of recording discs

Playing a specific section of a recording disc (BD-R/RE, DVD-R/RW, etc.) continuously for extended periods of time may reduce performance of the recorded surface and make the disc unplayable. To avoid this, take measures so that no single specific section is played for extended periods of time, and replace the disc periodically.

# Installation Procedure

### 1 Disconnect all cords connected to the set (including the power cord).

Before starting, check that there is no disc in the set.

### 2 Turn the set upside-down, and remove the screws on the sides of the set.

Remove the 2 screws from each side.

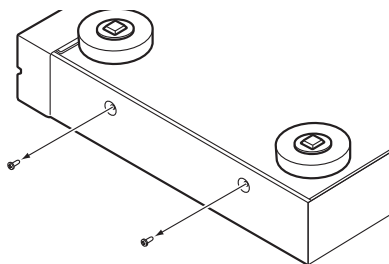

### ⚠ Caution

- When mounting, be sure to place the set on a stable surface, such as on a flat table, and raise the side of the set on which you are mounting the rack mount bracket by at least 10 mm. Mounting the rack mount bracket without raising the set at least 10 mm could damage the set.
- When mounting the rack mount bracket, be sure to use the screws removed from the player. Using other screws could damage the set or result in the set falling.

### 3 Mount the rack mount brackets.

Mount the rack mount brackets to the screw holes in the sides of the player using the screws removed from the player in step 2 (two screws on each side).

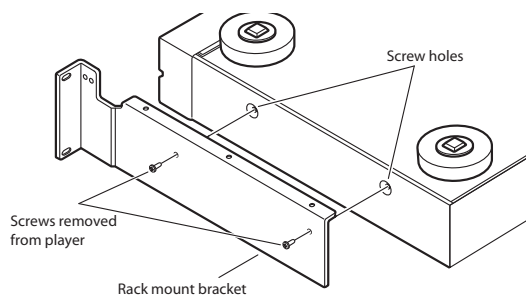

- The rack mount brackets are different for the left (L) and right (R) sides. Check the L and R marks on the rack mount brackets and be sure to mount them on the correct side.
- When mounting, first tighten the two screws removed from the player to the extent that the rack mount bracket moves when a gentle force is applied, check that the rack mount bracket is properly attached, then tighten the screws securely.



#### 4 Mount the underplate.

Insert the underplate between the left and right rack mount brackets, then mount with the included gray screw.

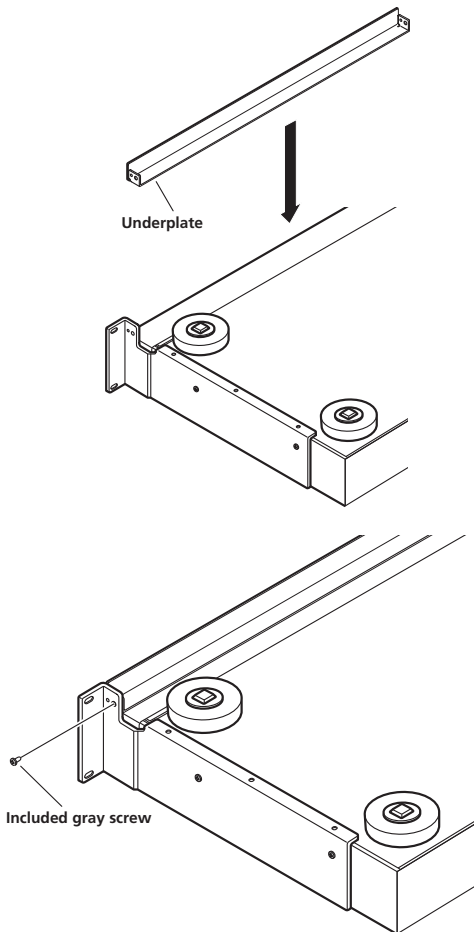

#### 5 Mount the set on the rack.

Check that the screws fastened in step 3 are securely tightened.

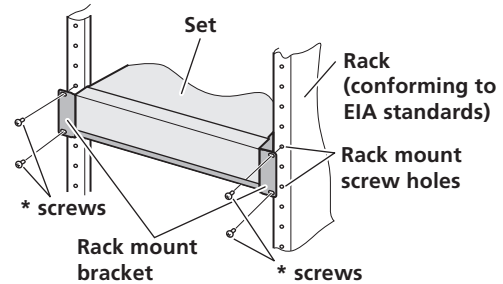

#### ⚠ Caution

- The rack mount brackets included with the set allow the set to be mounted on universal pitch or wide pitch racks conforming to EIA 19" standards.
- Check that the rack has the appropriate strength for the set's weight and usage environment before mounting.
- The \* screws for fixing the rack mount brackets to the rack are not included. Choose screws with the appropriate strength and length for the set's weight and usage environment to mount the set on the rack. To ensure that the set is fixed securely on the rack, be sure to fasten it with screws in all 4 rack mount screw holes.
- The mounting procedure should be performed by at least two people.
- Be very careful not to get your fingers, etc., caught between the rack mount brackets and the rack.

#### 6 Check that the screws fastened in step 5 are securely tightened.

Once this is checked, the procedure is finished.

- If there is any looseness in the screws \* or the screws removed from the player, vibrations generated by the rotation of discs in the player or by other products could cause noise or to lead the player falling off the rack, resulting in injury or damage to the equipment. Be sure to check that the screws are securely fastened.

#### ⚠ Caution

- Pay attention to the following when removing the set from the rack and moving it:
  - Be sure to remove any disc from the set.
  - Turn the set's power off, then disconnect connected cables, etc.
  - Be careful that the set does not fall when loosening the screws fastening it to the rack (the procedure should be performed by at least two people).
  - After removing the set from the rack, be sure to place it on a stable surface, such as on a flat table.

# Connecting up

Be sure to turn off the power and unplug the power cord from the power outlet whenever making or changing connections.

After connecting, make the settings at the **Setup Navigator** menu according to the type of cable connected (page 23).

Also refer to the operating instructions of the device being connected.

## Connecting using an HDMI cable

The audio and video signals can be transferred to HDMI-compatible devices as digital signals with no loss of sound or video quality.

### Note

- Make the settings at the **Setup Navigator** menu according to connected HDMI-compatible device (page 23).
- The **HDMI indicator** on the player's front panel lights when an HDMI-compatible device is connected to an **HDMI OUT** terminal (page 12).
- 1080p video signals may not be output, depending on the HDMI cable being used.

## About HDMI

This player incorporates High-Definition Multimedia Interface (HDMI™) technology.



*HDMI, the HDMI Logo and High-Definition Multimedia Interface are trademarks or registered trademarks of HDMI Licensing, LLC.*

The player supports Deep Color.

The conventional players can transmit a video signal with 8 bit color depth in the YCbCr 4:4:4 or RGB formats, the players supporting Deep Color can transmit a video signal with a color bit depth of greater than 8 bits per color component. Subtle color gradations can be reproduced when connected to a TV that supports Deep Color.

This product is compatible with "x.v.Color" that have the capability to realize a wide-gamut color space based on the xvYCC specifications.

Playing video signals conforming to "xvYCC" standards on this player when connected to an "x.v.Color"-compatible TV, etc., expands color reproduction

capabilities, allowing natural colors to be reproduced more faithfully than ever.

"x.v.Color" is a promotion name given to the products that have the capability to realize a wide-gamut color space based on the international standard specifications defined as xvYCC.

## x.v.Color

*"x.v.Color" and x.v.Color are trademarks of Sony Corporation.*

### ❖ Audio signals that can be transferred with the player's HDMI OUT terminal

- Dolby TrueHD
- Dolby Digital Plus
- Dolby Digital
- DTS-HD Master Audio
- DTS-HD High Resolution Audio
- DTS Digital Surround
- MPEG-2 AAC
- Linear PCM

Linear PCM audio signals meeting the following conditions can be output:

- Sampling frequency: 32 kHz to 192 kHz
- Number of channels: Up to 8 (up to 6 for a 192 kHz sampling frequency)

For details, see *About the audio output settings* on page 52.

### ❖ About the HDMI High Speed Transmission

This player outputs 1080/60p, 1080/50p and Deep Color video signals. If your TV supports 1080/60p, 1080/50p or Deep Color signals, use a High Speed HDMI™ cable in order to take advantage of the maximum performance the player and TV can offer. Also set **HDMI High Speed Transmission to On** (page 44).

High Speed HDMI™ cables are tested to carry signals up to 1080p. 1080/60i, 1080/60p, 720/60p, 1080/24p, 1080/50i, 1080/50p and 720/50p video signals that are capable of Deep Color can also be carried.

### Note

- Set **HDMI High Speed Transmission to Off** when using an HDMI cable other than a High Speed HDMI™ cable (a Standard HDMI™ cable).

- The following restrictions apply when **HDMI High Speed Transmission** is set to **Off**:
  - Deep Color signals are not output.
  - If the output video resolution is set to **Auto**, the signals are output with a resolution of 1080/60i or 1080/50i when TV's preferred resolution is 1080/60p or 1080/50p.
  - When the output video resolution is set to 480i/576i or 480p/576p, Dolby TrueHD and DTS-HD Master Audio audio signals are output as Dolby Digital, DTS Digital Surround or linear PCM signals. 96 kHz or 192 kHz multi-channel audio signals are output as linear PCM 2-channel audio signals (page 52).
- When an HDMI cable with a built-in equalizer is connected, it may not operate properly.

### ❖ When connected to a DVI device

- **It is not possible to connect DVI devices (computer displays, for example) that are not compatible with HDCP.** HDCP is a specification to protect audiovisual content across the DVI/HDMI interface.
- No audio signals are output. Connect using an audio cable, etc.
- This player is designed for connection with HDMI-compatible devices. When connected to a DVI device, it may not operate properly depending on the DVI device.

## About KURO LINK function

The functions listed below work when a Pioneer KURO LINK-compatible Flat Panel TV or AV system (AV receiver or amplifier, etc.) is connected to the player using an HDMI cable.

### Functions operated from the TV

Such player operations as starting and stopping playback and displaying the menus can be performed from the Flat Panel TV.

### Auto-select function

The input switches automatically on the Flat Panel TV and AV system (AV receiver or amplifier, etc.) when playback is started on the player or the Home Menu or Home Media Gallery is displayed. When the input is switched, the playback picture, the Home Menu or Home Media Gallery appears on the Flat Panel TV.

### Simultaneous power function

When playback on the player is started or the Home Menu or Home Media Gallery is displayed, if the Flat Panel TV's power was off, its power turns on automatically. When the Flat Panel TV's power is turned off, the player's power automatically turns off.

### Unified language function

When the language information from a connected Flat Panel TV is received, you can have the player's on-screen display language change automatically to that of the Flat Panel TV. This function is available only when playback is stopped and the menu screen is not displayed.

### ⚠ Caution

- Also refer to the operating instructions of the Flat Panel TV and AV system (AV receiver or amplifier, etc.).

### ✎ Note

- **CONTROL** on the player's front panel display lights when the KURO LINK function is activated (page 13).

### ❖ To use the KURO LINK function

- The KURO LINK function only works when outputting video signals from the **HDMI OUT** terminal.
- The KURO LINK function works when **KURO LINK** is set to **On** on the player (page 44).
- The KURO LINK function operates when KURO LINK is set to On for all devices connected with HDMI cables. Once connections and the settings of all the devices are finished, be sure to check that the player's picture is output to the Flat Panel TV. (Also check after changing the connected devices and reconnecting HDMI cables.) The KURO LINK function may not operate properly if the player's picture is not properly output to the Flat Panel TV.
- Use High Speed HDMI™ cables when using the KURO LINK function. The KURO LINK function may not operate properly if other HDMI cables are used.
- For some models, the KURO LINK function may be referred to as "HDMI Control".
- The Simultaneous power function is activated when the player is set as follows (page 44):

**Display Power On: On**  
**Display Power Off: On**

### ❖ About PQLS function

The PQLS (Precision Quartz Lock System) is a transfer control technology using the KURO LINK function. The player's output signals are controlled from the AV receiver or amplifier to achieve high quality sound playback using the quartz oscillator of AV receiver or amplifier. This eliminates the influence of the jitter generated upon transfer which can adversely affect the sound quality.

- The player supports the "PQLS 2ch Audio" function that is only activated when playing audio CDs (CD-DAs), and the "PQLS Multi Surround" function that is activated when playing all discs (BDs, DVDs, etc.) with audio output in linear PCM.
- The "PQLS 2ch Audio" function is only activated when a Pioneer AV receiver or amplifier compatible with the "PQLS 2ch Audio" function is connected directly to the player's **HDMI OUT** terminal using an HDMI cable, and when the player is set as follows (page 44):  
**KURO LINK: On**  
**PQLS: Auto**
- The "PQLS Multi Surround" function is only activated when a Pioneer AV receiver or amplifier compatible with the "PQLS Multi Surround" function is connected directly to the player's **HDMI OUT**

terminal using an HDMI cable, and when the player is set as follows (page 44):

**HDMI Audio Out: PCM**

**KURO LINK: On**

**PQLS: Auto**

- Also refer to the operating instructions of AV receiver or amplifier.
- Please see the Pioneer website for AV receivers or amplifiers that support the PQLS function.

### ⚠ Caution

- If the output video resolution is switched, the PQLS function may not work. The function will work again once playback has been stopped then restarted.

### 📝 Note

- PQLS on the player's front panel display lights when the PQLS function is activated (page 13).

## ❖ About connections to components of other makes supporting the KURO LINK function

The functions listed below work when a TV or AV system (AV receiver or amplifier, etc.) supporting the player's KURO LINK function is connected to the player using an HDMI cable. (Depending on your TV or AV system (AV receiver or amplifier, etc.), it could happen that not all of the functions will work.)

- Functions operated from the TV
- Auto-select function
- Simultaneous power function
- Unified language function

Please see the Pioneer website for the latest information on brands and model numbers of other brands that support the KURO LINK function.

## Connecting a TV

See *Connecting an AV receiver or amplifier* below to connect an AV receiver or amplifier using an HDMI cable.

### ⚠ Caution

- Hold the plug when connecting and disconnecting the cable.
- Placing a load on the plug could result in faulty contact and no video signals being output.

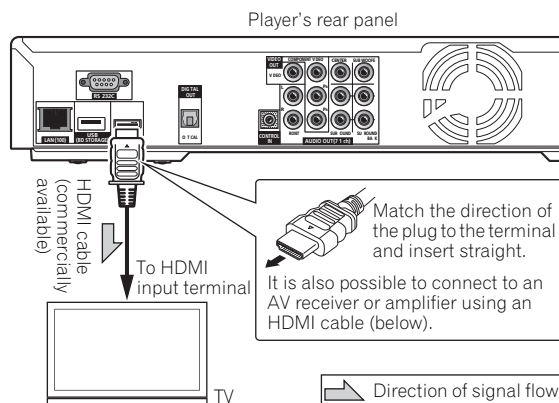

## Connecting an AV receiver or amplifier

Connect to an AV receiver or amplifier in order to enjoy the surround sound of Dolby TrueHD, Dolby Digital Plus, Dolby Digital, DTS-HD Master Audio, DTS-HD High Resolution Audio or DTS Digital Surround. For instructions on connecting the TV and speakers to the AV receiver or amplifier, refer to the operating instructions of AV receiver or amplifier.

### ⚠ Caution

- Hold the plug when connecting and disconnecting the cable.
- Placing a load on the plug could result in faulty contact and no video signals being output.

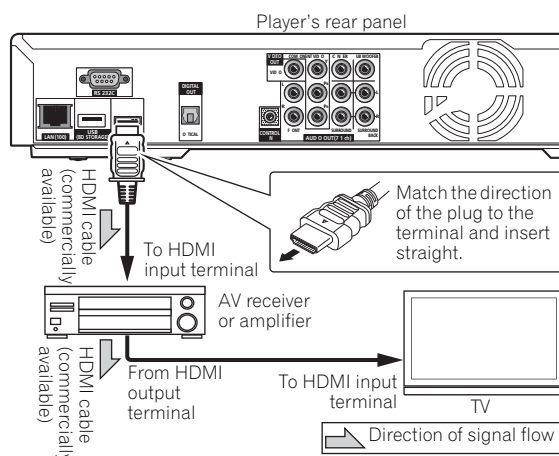

## Connecting video and audio cables

### Note

- Make the settings in the **Setup Navigator** menu according to the type of cable connected (page 23).
- To output video signals from this player, connect using one of the following (not including when connected using an HDMI cable): a component video cable or a video cable.

## Connecting a TV using a video/audio cable

### Caution

- **Connect the player's video output directly to your TV.**  
This player supports analog copy protection technology. Therefore the picture may not be displayed properly if connected to a TV via a DVD recorder/video deck or when playing the player's output material that is recorded by a DVD recorder/video deck. Furthermore, the picture may not be displayed properly due to the copy protection when the player is connected to a TV with a built-in video deck. For details, contact the manufacturer of your TV.

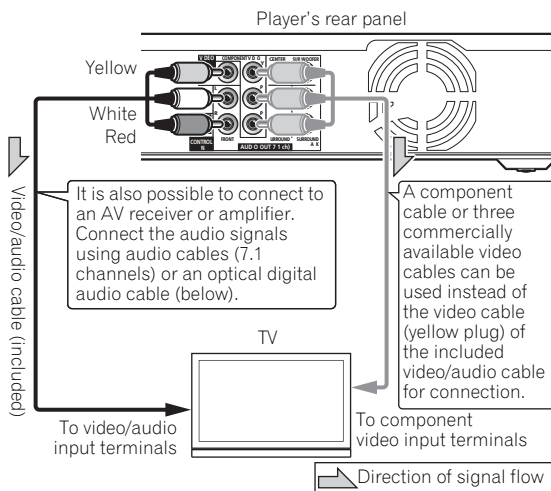

### Note

- Video signals are output with a resolution of 480/60i or 576/50i when connected using a video cable.
- When connected to the TV using a component video cable, video signals are not output with a resolution of 1080/60p, 1080/24p, 1080/50i, 1080/50p or 720/50p.
- Depending on the output video resolution setting, the picture may not be output (page 27).

## Connecting an AV receiver or amplifier using audio cables

**When connecting to a 7.1-channel compatible AV receiver or amplifier** – Connect using 4 audio cables (diagram below).

**When connecting to a 5.1-channel compatible AV receiver or amplifier** – Connect using 3 audio cables (do not connect to the surround back left and right terminals).

- To switch the video from the AV receiver or amplifier, also connect the video output terminals.
- After connecting, set **Audio Output Mode** to **Multi-channel** (page 43).

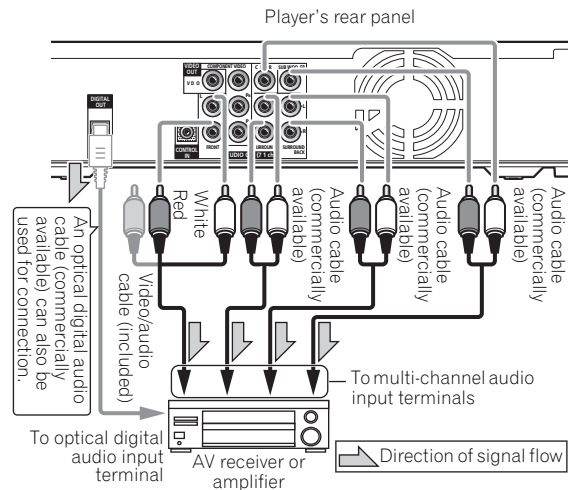

### Note

- To connect to the 2-channel audio input terminals on a TV, etc., connect to **FRONT (L/R)**.

## Connecting components to the USB port

The data downloaded with the BD-LIVE function and the data used with the BONUSVIEW function when playing BD-ROMs can be stored on a device connected to the **USB** port (external storage).

## About USB (external storage) devices

The USB (external storage) devices that can be connected to the player are as shown below.

- USB 2.0-compatible memory devices or hard disks
- FAT16 or FAT32 file system, minimum 1 GB capacity (2 GB or more recommended)

### Note

- Devices formatted with a file system other than the above cannot be used. Such devices may however be usable if they are formatted from the player.
- External storage devices may not be recognized if they contain multiple partitions.
- Some external storage devices may not operate with this player.
- Operation of external storage devices (USB memory devices, external hard disks, etc.) is not guaranteed.

## Connecting the USB (external storage) device

### Caution

- Be sure to turn the player's power off before connecting or disconnecting external storage devices.
- Use empty external storage devices (on which nothing is stored).
- When using an external hard disk as the external storage device, be sure to turn on the hard disk's power before turning on the player's power.
- If the external storage device is write-protected, be sure to disable the write-protection.
- When connecting the USB cable, hold onto the plug, set the plug in the proper direction for the port and insert it horizontally.
- Placing excessive loads on the plug may result in poor contact, making it impossible to write data on the external storage device.
- The player is equipped with an internal storage. This internal storage cannot be used when an external storage device is connected.
- When a USB memory device or external hard disk is connected and the player's power is turned on, do not unplug the power cord.

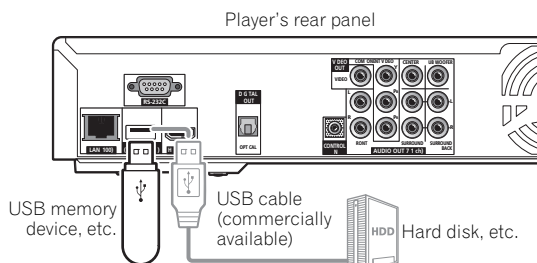

### Note

- The **EXT** indicator on the player's front panel display lights when data can be stored on the external storage (page 13).
- Devices may not work if connected to the **USB** port via a memory card reader or USB hub.
- Use a USB cable with a length of 2 meters or less.

## Network connection

BD-LIVE functions such as downloading movie trailers or additional audio and subtitle languages and playing on-line games can be enjoyed over the Internet. The player's software can also be updated over the Internet (page 51). Connect an Ethernet hub (or a router with hub functionality) that is connected to the Internet to the player. Be sure to use a 100BASE-TX compatible Ethernet hub or router.

### Connecting via an Ethernet hub

The player can be connected to an Ethernet hub using a LAN cable.

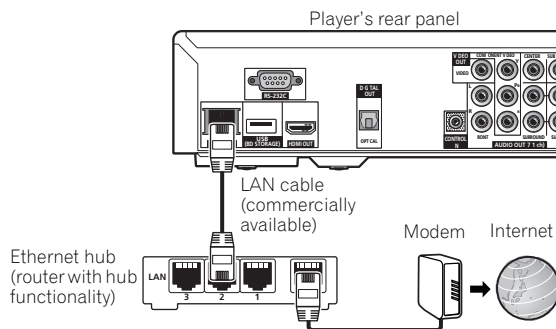

### Note

- **LAN** on the player's front panel display lights when there is an active local area network (LAN) connection (page 13).
- If there is an available DHCP server in your local area network, the IP address is obtained automatically. Otherwise, set IP address manually (page 48).
- For some Internet service providers, you may have to set the individual network configuration manually. In this case, see page 48.
- Pioneer is not responsible for any malfunction of the player due to communication error/malfunctions associated with your network connection and/or your connected equipment. Please contact your Internet service provider or network device manufacturer.

## Connecting the power cord

Connect the power cord after all the connections between devices have been completed.

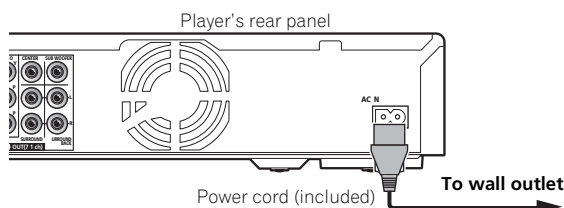

## Chapter 4

# Getting Started

## Making settings using the Setup Navigator menu

Be sure to perform these settings when using the player for the first time.

### ⚠ Caution

- Before turning on the power, check that the connections between the player and other devices are correct. Also, turn on the power of the devices connected to the player before turning on the player's power.
- The screen in step 11 and test tones are output simultaneously according to the settings in steps 4 to 7. Lower the volume of the devices connected with the player.

### 📝 Note

- By factory default, the KURO LINK function is not activated. To activate the KURO LINK function using Setup Navigator, **KURO LINK** is set to **On** on the player (page 44), and if a Pioneer KURO LINK-compatible Flat Panel TV is connected, turn on the TV's KURO LINK function.
- When a Pioneer Flat Panel TV or front projector compatible with the KURO LINK function is connected to the player using an HDMI cable, the player is automatically set to the optimum picture quality for the connected device.

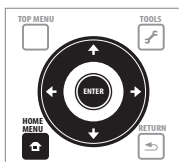

### 1 Turn on the TV's power and switch the input.

See the TV's operating instructions for instructions on operating the TV.

### 2 Turn on the player's power.

Press **⏻** **STANDBY/ON**.

Check that the **Setup Navigator** menu is displayed.

### ❖ If the Setup Navigator menu is not displayed

▶ Press **🏠** **HOME MENU** to display the Home Menu, select **Initial Setup** → **Setup Navigator** → **Start**, then press **ENTER**.

### 3 Select the OSD language.

Use **↑/↓** to select, then press **ENTER**.

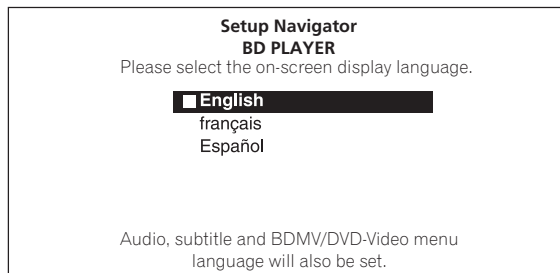

When a Pioneer Flat Panel TV that is compatible with KURO LINK is connected to this player's **HDMI OUT** terminal, language settings are imported from the Pioneer Flat Panel TV's language settings before **Setup Navigator** begins.

### 4 Select and set the video and audio output terminals.

Select the actually connected video and audio output terminals.

Use **↑/↓/←/→** to select, then press **ENTER**.

Setting item	Output terminal name	
Video	HDMI	HDMI OUT
	COMPONENT VIDEO	VIDEO OUT COMPONENT VIDEO
	VIDEO	VIDEO
Audio	HDMI	HDMI OUT
	DIGITAL AUDIO	DIGITAL OUT
	ANALOG AUDIO	AUDIO OUT

### ⚠ Caution

- When **HDMI** is selected for **Video**, no video signals are output from the **COMPONENT VIDEO** or **VIDEO** output terminals.
- When **COMPONENT VIDEO** or **VIDEO** is selected at **Video**, no video signals are output from the **HDMI OUT** terminal.
- The video and audio signals output from the set output terminals are output synchronously (lip synchronization).
- When **COMPONENT VIDEO** or **VIDEO** is selected at **Video**, no sound is output if **HDMI** is selected at **Audio**.  
Follow the procedure below to redo the connections, then select the proper connection at the setup screen.

- When connecting using component video cables or a video cable to watch the picture, connect to an AV receiver or amplifier, or a TV using either analog audio cables (7.1 channels or 2 channels), an optical digital audio cable (page 21).
- To listen to audio with the player connected to an AV receiver or amplifier with an HDMI cable, connect the TV to the AV receiver or amplifier using an HDMI cable (page 20).
- When **HDMI** or **DIGITAL AUDIO** is selected at **Audio**, linear PCM audio signals (2 channels) are output from all terminals other than the ones selected at **Audio**.
- When **ANALOG AUDIO** is selected at **Audio**, no audio signals are output from the **HDMI OUT** or **DIGITAL OUT** terminals.

**For steps 5 to 8, the step to which you should proceed depends on the combination of the Video and Audio settings.**

### 5 Select and set the HDMI High Speed Transmission setting for the HDMI OUT terminal.

Use  $\leftarrow/\rightarrow$  to select, then press **ENTER**.

When **HDMI High Speed Transmission** for the **HDMI OUT** terminal is set to **On**, use a High Speed HDMI™ cable. The picture and sound may not be output properly if any other HDMI cable (for example a standard HDMI™ cable) or an HDMI cable with built-in equalizer is used.

### 6 Select the output video resolution from the COMPONENT VIDEO output terminals.

Use  $\uparrow/\downarrow$  to select, then press **ENTER**.

For details on the resolution settings, see *Switching the output video resolution* on page 27.

### 7 Select the aspect ratio of your TV.

Use  $\uparrow/\downarrow$  to select, then press **ENTER**.

### 8 Select the PQLS.

Use  $\uparrow/\downarrow$  to select, then press **ENTER**.

#### **Note**

- Only when a Pioneer AV receiver or amplifier is connected, PQLS Screen appears.
- The PQLS function works when linear PCM audio signals are output. Therefore the linear PCM audio signals obtained by decoding all audio signals are output from **HDMI OUT** terminal. For details, see *About the audio output settings* on page 52.
- When **Use** is select, the player is set to the settings below.  
**HDMI Audio Out: PCM**  
**KURO LINK: On**  
**PQLS: Auto**
- For details on the PQLS function, *About PQLS function* on page 19.

### 9 Check the settings.

Select **Proceed**, then press **ENTER**.

### 10 Output test tones.

Use  $\leftarrow/\rightarrow$  to select **Yes**, then press **ENTER**.

### 11 Finish the Setup Navigator menu.

Use  $\leftarrow/\rightarrow$  to select **Finish**, then press **ENTER**.

To redo the settings from the start, select **Go Back**.

Depending on the output terminal setting of step 4 or the HDMI cable being used, it may happen that no picture and/or sound is output. If this happens, the setup returns to step 4 if there is no operation for over 30 seconds. Once the setup returns to step 4, redo the settings according to the connected devices and the HDMI cable being used.

### 12 Checking the picture quality settings or setting the picture quality.

If a Pioneer Flat Panel TV or projector is connected to the player and **HDMI** is selected for **Video** in step 4, the player sets the picture quality automatically. The automatic picture quality setting screen appears. Press **ENTER**.

When the automatic picture quality setting screen does not appear, the manual picture quality setting screen appears. Use  $\uparrow/\downarrow$  to select the connected component, then press **ENTER**.

## Operating the TV with the player's remote control

When the manufacturer code for your brand of TV is set on the player's remote control, the TV can be operated using the player's remote control.

#### **Caution**

- For some models it may not be possible to operate the TV with the player's remote control, even for TVs of brands listed on the manufacturer code list.
- The settings may be restored to the factory defaults when batteries are replaced. If this happens, set up the settings again.

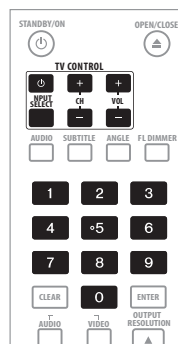

### 1 Input the 2-digit manufacturer code.

Press the number buttons (0 to 9) to input the code while pressing **TV CONTROL**  $\phi$ .





### Note

- The factory setting is 00 (PIONEER).
- If you make a mistake when inputting the code, release **TV CONTROL**  $\odot$  then start over from the beginning.
- When there are multiple codes for a manufacturer, try inputting them in the indicated order until the TV can be operated.

## 2 Check that the TV can be operated.

Operate the TV using **TV CONTROL**.

$\odot$  – Press to turn the TV's power on and off.

**INPUT SELECT** – Press to switch the TV's input.

**CH +/-** – Press to select the TV channel.

**VOL +/-** – Press to adjust the volume.

## TV Preset code list

### Manufacturer Code(s)

<b>PIONEER</b> 00, 31, 32, 07, 36, 42, 51, 22	<b>ERRES</b> 07
<b>ACURA</b> 44	<b>FERGUSON</b> 07, 36, 51
<b>ADMIRAL</b> 31	<b>FINLANDIA</b> 35, 43, 54
<b>AIWA</b> 60	<b>FINLUX</b> 32, 07, 45, 48, 53, 54
<b>AKAI</b> 32, 35, 42	<b>FIRSTLINE</b> 40, 44
<b>AKURA</b> 41	<b>FISHER</b> 32, 35, 38, 45
<b>ALBA</b> 07, 39, 41, 44	<b>FORMENTI</b> 32, 07, 42
<b>AMSTRAD</b> 42, 44, 47	<b>FRONTECH</b> 31, 42, 46
<b>ANITECH</b> 44	<b>FRONTECH/PROTECH</b> 32
<b>ASA</b> 45	<b>FUJITSU</b> 48
<b>ASUKA</b> 41	<b>FUNAI</b> 40, 46, 58
<b>AUDIOGONIC</b> 07, 36	<b>GBC</b> 32, 42
<b>BASIC LINE</b> 41, 44	<b>GE</b> 00, 01, 08, 07, 10, 11, 17, 02, 28, 18
<b>BAUR</b> 31, 07, 42	<b>GEC</b> 07, 34, 48
<b>BEKO</b> 38	<b>GELOSO</b> 32, 44
<b>BEON</b> 07	<b>GENERAL</b> 29
<b>BLAUPUNKT</b> 31	<b>GENEXXA</b> 31, 41
<b>BLUE SKY</b> 41	<b>GOLDSTAR</b> 10, 23, 21, 02, 07, 50
<b>BLUE STAR</b> 18	<b>GOODMANS</b> 07, 39, 47, 48, 56
<b>BPL</b> 18	<b>GORENJE</b> 38
<b>BRANDT</b> 36	<b>GPM</b> 41
<b>BTC</b> 41	<b>GRAETZ</b> 31, 42
<b>BUSH</b> 07, 41, 42, 44, 47, 56	<b>GRANADA</b> 07, 35, 42, 43, 48
<b>CASCADE</b> 44	<b>GRADIENTE</b> 30, 57
<b>CATHAY</b> 07	<b>GRANDIN</b> 18
<b>CENTURION</b> 07	<b>GRUNDIG</b> 31, 53
<b>CGB</b> 42	<b>HANSEATIC</b> 07, 42
<b>CIMLINE</b> 44	<b>HCM</b> 18, 44
<b>CLARIVOX</b> 07	<b>HINARI</b> 07, 41, 44
<b>CLATRONIC</b> 38	<b>HISAWA</b> 18
<b>CONDOR</b> 38	<b>HITACHI</b> 31, 33, 34, 36, 42, 43, 54, 06, 10, 24, 25, 18
<b>CONTEC</b> 44	<b>HUANYU</b> 56
<b>CROSLEY</b> 32	<b>HYPSON</b> 07, 18, 46
<b>CROWN</b> 38, 44	<b>ICE</b> 46, 47
<b>CRYSTAL</b> 42	<b>IMPERIAL</b> 38, 42
<b>CYBERTRON</b> 41	<b>INDIANA</b> 07
<b>DAEWOO</b> 07, 44, 56	<b>INGELEN</b> 31
<b>DAINICHI</b> 41	<b>INTERFUNK</b> 31, 32, 07, 42
<b>DANSAI</b> 07	<b>INTERVISION</b> 46, 49
<b>DAYTON</b> 44	<b>ISUKAI</b> 41
<b>DECCA</b> 07, 48	<b>ITC</b> 42
<b>DIXI</b> 07, 44	<b>ITT</b> 31, 32, 42
<b>DUMONT</b> 53	<b>JEC</b> 05
<b>ELIN</b> 07	<b>JVC</b> 13, 23
<b>ELITE</b> 41	<b>KAISUI</b> 18, 41, 44
<b>ELTA</b> 44	<b>KAPSCH</b> 31
<b>EMERSON</b> 42	
	<b>KENDO</b> 42
	<b>KENNEDY</b> 32, 42
	<b>KORPEL</b> 07
	<b>KOYODA</b> 44
	<b>LEYCO</b> 07, 40, 46, 48
	<b>LIESENK&amp;TTER</b> 07
	<b>LOEWE</b> 07
	<b>LUXOR</b> 32, 42, 43
	<b>M-ELECTRONIC</b> 31, 44, 45, 54, 56, 07, 36, 51
	<b>MAGNADYNE</b> 32, 49
	<b>MAGNAFON</b> 49
	<b>MAGNAVOX</b> 07, 10, 03, 12, 29
	<b>MANESTH</b> 39, 46
	<b>MARANTZ</b> 07
	<b>MARK</b> 07
	<b>MATSUI</b> 07, 39, 40, 42, 44, 47, 48
	<b>MCMICHAEL</b> 34
	<b>MEDIATOR</b> 07
	<b>MEMOREX</b> 44
	<b>METZ</b> 31
	<b>MINERVA</b> 31, 53
	<b>mitsubishi</b> 09, 10, 02, 21, 31
	<b>MULTITECH</b> 44, 49
	<b>NEC</b> 59
	<b>NECKERMANN</b> 31, 07
	<b>NEI</b> 07, 42
	<b>NIKKAI</b> 05, 07, 41, 46, 48
	<b>NOBLIKO</b> 49
	<b>NOKIA</b> 32, 42, 52
	<b>NORDMENDE</b> 32, 36, 51, 52
	<b>OCEANIC</b> 31, 32, 42
	<b>ORION</b> 32, 07, 39, 40
	<b>OSAKI</b> 41, 46, 48
	<b>OSO</b> 41
	<b>OSUME</b> 48
	<b>OTTO VERSAND</b> 31, 32, 07, 42
	<b>PALLADIUM</b> 38
	<b>PANAMA</b> 46
	<b>PANASONIC</b> 31, 07, 08, 42, 22
	<b>PATHO CINEMA</b> 42
	<b>PAUSA</b> 44
	<b>PHILCO</b> 32, 42
	<b>PHILIPS</b> 31, 07, 34, 56, 68
	<b>PHOENIX</b> 32
	<b>PHONOLA</b> 07
	<b>PROFEX</b> 42, 44
	<b>PROTECH</b> 07, 42, 44, 46, 49
	<b>QUELLE</b> 31, 32, 07, 42, 45, 53
	<b>R-LINE</b> 07
	<b>RADIOLA</b> 07
	<b>RADIOSHACK</b> 10, 23, 21, 02
	<b>RBM</b> 53
	<b>RCA</b> 01, 10, 15, 16, 17, 18, 61, 62, 09
	<b>REDIFFUSION</b> 32, 42
	<b>REX</b> 31, 46
	<b>ROADSTAR</b> 41, 44, 46
	<b>SABA</b> 31, 36, 42, 51
	<b>SAISHO</b> 39, 44, 46
	<b>SALORA</b> 31, 32, 42, 43
	<b>SAMBERS</b> 49
	<b>SAMSUNG</b> 07, 38, 44, 46, 69, 70
	<b>SANYO</b> 35, 45, 48, 21, 14, 91
	<b>SBR</b> 07, 34
	<b>SCHAUB LORENZ</b> 42
	<b>SCHNEIDER</b> 07, 41, 47
	<b>SEG</b> 42, 46
	<b>SEI</b> 32, 40, 49
	<b>SELECO</b> 31, 42
	<b>SHARP</b> 02, 19, 27, 67, 90
	<b>SIAREM</b> 32, 49
	<b>SIEMENS</b> 31
	<b>SINUDYNE</b> 32, 39, 40, 49
	<b>SKANTIC</b> 43
	<b>SOLAVOX</b> 31
	<b>SONOKO</b> 07, 44
	<b>SONOLOR</b> 31, 35
	<b>SONTEC</b> 07
	<b>SONY</b> 04
	<b>SOUNDWAVE</b> 07
	<b>STANDARD</b> 41, 44
	<b>STERN</b> 31
	<b>SUSUMU</b> 41
	<b>SYSLINE</b> 07
	<b>TANDY</b> 31, 41, 48
	<b>TASHIKO</b> 34
	<b>TATUNG</b> 07, 48
	<b>TEC</b> 42
	<b>TELEAVIA</b> 36
	<b>TELEFUNKEN</b> 36, 37, 52
	<b>TELETECH</b> 44
	<b>TENSAI</b> 40, 41
	<b>THOMSON</b> 36, 51, 52, 63
	<b>THORN</b> 31, 07, 42, 45, 48
	<b>TOMASHI</b> 18
	<b>TOSHIBA</b> 05, 02, 26, 21, 53
	<b>TOWADA</b> 42
	<b>ULTRAVOX</b> 32, 42, 49
	<b>UNIDEN</b> 92
	<b>UNIVERSUM</b> 31, 07, 38, 42, 45, 46, 54
	<b>VESTEL</b> 07
	<b>VICTOR</b> 13
	<b>VOXSON</b> 31
	<b>WALTHAM</b> 43
	<b>WATSON</b> 07
	<b>WATT RADIO</b> 32, 42, 49
	<b>WHITE WESTINGHOUSE</b> 07
	<b>YOKO</b> 07, 42, 46
	<b>ZENITH</b> 03, 20

## 04 Using the TOOLS menu

Various functions can be called out according to the player's operating status.

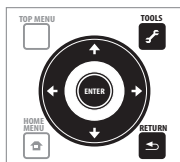

### 1 Display the TOOLS menu.

Press **TOOLS**.

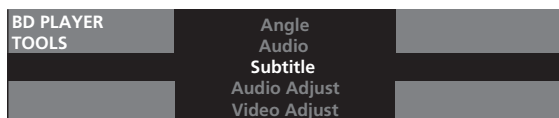

### 2 Select and set the item.

Use **↑/↓** to select, then press **ENTER**.



#### Note

- Items that cannot be changed are displayed in gray. The items that can be selected depend on the player's status.

### ❖ To change the setting of the selected item

Use **←/→** to change.

### ❖ To close the TOOLS menu

Press **TOOLS** or **RETURN**.

### ❖ TOOLS menu item list

Item	Description
Play from Beginning	Play the selected title, track or file from the start.
Slideshow	Play a slideshow of the image files on the selected disc or folder.
Play Mode	Display the Play Mode screen (page 33).
Video Adjust	Display the picture quality adjustment screen (page 39).
Secondary Video	Switch the BD-ROM's secondary video (Picture-in-Picture) (page 31).
Subtitle	Switch the subtitles (page 30).
Angle	Switch the BD-ROM/DVD-Video disc's camera angles (page 30).
Rotate	Rotate the image while playing a slideshow (page 37).
Audio Adjust	Display the audio adjustment menu (page 40).
Audio	Switch the audio (page 31).
Secondary Audio	Switch the BD-ROM's secondary audio (page 31).

Item	Description
Now Playing	Display the playback screen of the currently playing track or file.
Original/Play List	Switch the DVD-R/-RW's (VR format) list screen between the original list and the playlist.
Add to HMG Playlist	Add the selected track or file to the HMG Playlist (page 37).
Delete from HMG Playlist	Delete the selected track or file from the HMG Playlist (page 38).
Output Video Resolution	Switch the output video resolution from the various output terminals (page 27).
Delete all playlists	Clears all the titles/chapters from the playlist.

## Switching the video output terminal to be viewed

Use the procedure below to switch the video output signal to be viewed between the **HDMI OUT** terminal and an analog output terminal (**COMPONENT VIDEO** or **VIDEO** output terminals).

### ⚠ Caution

- The picture may not be displayed for a while when the video output terminal is switched.
- When the **HDMI OUT** terminal is selected, no video signals are output from the other video output terminals.
- When a video output terminal other than the **HDMI OUT** terminal is selected, no audio and video signals are output from the **HDMI OUT** terminal.

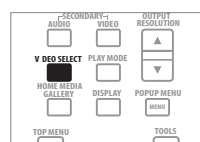

### ▶ Press VIDEO SELECT.

- The current video output terminal is displayed on the TV screen and on the player's front panel display. To switch the video output terminals, press **VIDEO SELECT** again or press **↑/↓**.

#### Example:

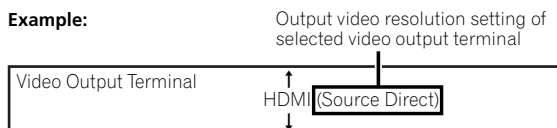

- The video output terminal setting can also be switched by pressing **◀◀ ◀▶ ▶▶ ▶▶▶▶** on the player's front panel.

# Switching the output video resolution

Use the procedure below to switch the output video resolution from the various video output terminals.

## ⚠ Caution

- On some devices (TV, AV receiver or amplifier, etc.), the video or audio may not be output properly when the resolution is switched. If this happens, use **OUTPUT RESOLUTION** to set a resolution at which the video and audio are properly output.
- When video signals are being output with a resolution of 1080/60i, 1080/60p, 720/60p, 1080/24p, 1080/50i, 1080/50p or 720/50p from the **HDMI OUT** terminal or **COMPONENT VIDEO** output terminals, the picture may be output with an aspect ratio of 16:9, even if the **TV Aspect Ratio** is set to **4:3 (Standard)**.
- The picture may not be displayed for a while when the resolution is switched.

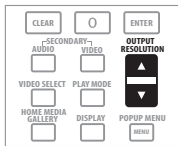

## ▶ Press **OUTPUT RESOLUTION**.

- The current output video resolution setting is displayed on the TV screen and on the player's front panel display. To switch the output video resolution, press **OUTPUT RESOLUTION** again or press **↑/↓**.
- The output video resolution depends on the video output terminal (page 28).

### Example:

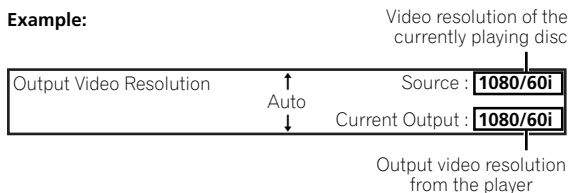

- The output video resolution setting can also be switched by selecting **Output Video Resolution** from the **TOOLS** menu.

## ❖ About the frame/field frequency and NTSC/PAL TV systems

By factory default setting, the frame/field frequency is set for an output of 60 Hz, and the TV system format for the video signal output from the **VIDEO** output terminals depends on the **NTSC on PAL TV** setting. When sources with a frame/field frequency of 50 Hz are played, the output frame/field frequency automatically switches to 50 Hz, and the video signal output from the **VIDEO** output terminals is set to be output in the PAL TV system format.

When playback is stopped, the frame/field frequency and TV system settings remain at the settings last used. The frame/field frequency and TV system settings do not change even when the power is turned off. They only switch when a video material with a different frame/field frequency is played.

If the picture is not displayed on the TV when a source with a different frame/field frequency is played, use the procedure below to switch the frame/field frequency and TV system settings for the signal output from the player.

Eject the disc, then press the **▲ OPEN/CLOSE** button on the front panel while pressing the **▶** button to switch to a different frame/field frequency. The frame/field frequency switches between 50 Hz and 60 Hz each time this operation is performed. The indicator for the frame frequency's current setting lights on the front panel display (page 13).

## ❖ About Film material

The film material is a video signal with a frame rate of 24 frames/second. For example, these materials include 1080/24p, 720/24p, etc.

## ❖ To output film material

To output 1080/24p film material from **HDMI OUT** terminal, set the output video resolution to either **Auto** or **Source Direct**.

## ⚠ Caution

- 1080/24p signals can only be output from the **HDMI OUT** terminal. They cannot be output from other video terminals.
- When **Auto** is selected, the picture is output at 60 frames/second if your TV is not compatible with 1080/24p signals.
- When **Source Direct** is selected, the signals are output as such, even if your TV is not compatible with 1080/24p signals. If the picture is not displayed properly, use **OUTPUT RESOLUTION** to set an output video resolution at which the video and audio signals are properly output.
- Even if **Auto** or **Source Direct** is selected, 720/24p video signals are output at 60 frames/second.

## ❖ About the output video resolution

The output video resolution setting and the resolution of the picture that is actually output differ for the different terminals. See the table below. The table below shows the output video resolution for the different terminals when the frame/field frequency of the playback source is 50 Hz on the upper line, the resolutions when the source's frame/field frequency is 60 Hz and 24 Hz on the lower line.

Output video resolution setting	HDMI <sup>1</sup>		COMPONENT VIDEO/VIDEO <sup>1</sup>			
	HDMI OUT terminal	COMPONENT VIDEO/VIDEO output terminals	HDMI OUT terminal	COMPONENT VIDEO output terminals <sup>2</sup>	VIDEO output terminal <sup>2</sup>	(TV system)
Auto <sup>3</sup>	Resolution preferred by TV <sup>4,5,6</sup>	No video signals are output	No video signals are output	—	—	—
576i or 480i	576/50i	No video signals are output	No video signals are output	576/50i	576/50i	PAL
	480/60i			480/60i	480/60i	* <sup>7</sup>
576p or 480p	576/50p			576/50p	576/50i	PAL
	480/60p			480/60p	480/60i	* <sup>7</sup>
1080i	1080/50i			576/50p	576/50i	PAL
	1080/60i			1080/60i <sup>8,9</sup>	480/60i	* <sup>7</sup>
1080p <sup>3</sup>	1080/50p <sup>10,11</sup>			—	—	—
	1080/60p <sup>10,11</sup>			—	—	—
Source Direct	Resolution recorded on disc <sup>5,12,13</sup>			Resolution recorded on disc <sup>9,12,13,14</sup>	576/50i	PAL
					480/60i	* <sup>7</sup>

1. The video output terminal set at **Video** in the **Setup Navigator** (page 23) or the video output terminal selected with **VIDEO SELECT** (page 26).
2. Depending on the BD, the pictures may not be output.
3. This cannot be selected when the video output terminal is set to **COMPONENT VIDEO/VIDEO**.
4. The pictures are output with the preferred output resolution of the device (TV, AV receiver or amplifier, etc.) connected to **HDMI OUT** terminal.
5. For details on the output of film material (1080/24p or 720/24p video signals), see *To output film material* on page 27.
6. Sources with a resolution of 720/60p, 720/50p and 720/24p are output at 1080/60i or 1080/50i even if the TV's recommended resolution is 1080/60p or 1080/50p.
7. Depends on the **NTSC on PAL TV** setting (page 43).
8. DVD-Video or DVD-R/-RW (VR format) may be output at 480/60p.
9. BD-ROM or BD-R/-RE may be output at 480/60p.
10. Depending on the connected HDMI cable, the video signals may not be output.
11. Sources with a resolution of 720/60p, 720/50p and 720/24p are output at 1080/60i or 1080/50i.
12. Depending on the connected TV, the video signals may not be output.
13. 720/24p film material is output at 720/60p.
14. 1080/24p film material is output at 1080/60i.

## Playing discs or files

This section describes the player's main operations. For the types of discs that can be played, see *Playable discs* on page 8. For the types of files that can be played, see *Playable files* on page 10. Image and audio files recorded on discs are played with the Home Media Gallery (page 36).

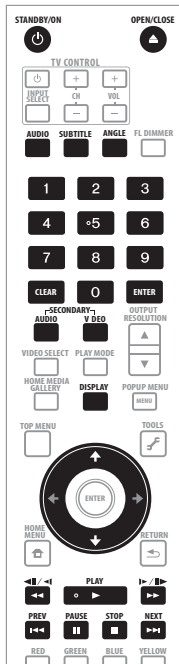

- 1 Press **⏻** **STANDBY/ON** to turn on the power. Turn the TV's power on and switch its input beforehand.
- 2 Press **⏪** **OPEN/CLOSE** to open the disc tray and load the disc.

### Note

- Load the disc with the printed side facing up.
- Several dozen seconds are required to read the disc. Once reading is completed, the type of disc is displayed on the player's front panel display.



- 3 Press **▶** **PLAY** to play the disc. ▶ on the player's front panel display lights during playback.

- To pause, press **⏸** **PAUSE** during playback. **⏸** on the player's front panel display lights when playback is paused.
- To stop, press **■** **STOP** during playback.

### Note

- Some discs start playing automatically when the disc tray is closed.
- DVD-Video discs have parental lock features. Input the password registered in the player's settings to unlock the parental lock. For details, see page 50.
- For some BD-R/-RE, playback protection is set for the disc or titles. Input the code number set for the disc to unlock the protection.
- Check *Troubleshooting* on page 67 if video or audio signals are not being output properly.

### ❖ If the disc menu is displayed

For some discs, the disc menu is displayed automatically when playback starts. The contents of the disc menu and the way to operate differ from disc to disc.

### ❖ Resuming playback from where it was stopped (resume playback function)

- When **■** **STOP** is pressed during playback, the point at which the disc stopped is stored in the memory. When **▶** **PLAY** is pressed, playback resumes from that point.
- For audio CDs and audio files, playback starts from the beginning of the track/file that was playing.
- If the stop mode was set while playing a slideshow of image files, playback starts from the image file last displayed.
- To cancel the resume playback function, press **■** **STOP** while playback is stopped.

### Note

- The resume playback function is canceled automatically in the following cases:
  - When the disc tray is opened.
  - When the file list window is switched.
  - When the power is turned off. (For BDs and DVDs this does not cancel the resume playback function.)
- The resume playback function cannot be used for some discs.

## Forward and reverse scanning

- ▶ **During playback, press ◀◀ or ▶▶.**
  - The scanning speed switches each time the button is pressed. The speed steps depend on the disc or file (the speed is displayed on the TV screen).
  - Forward or reverse scanning is also possible by holding the button down. Normal playback resumes when the button is released.

### ❖ To resume normal playback

- ▶ Press ▶ **PLAY**.

## Playing specific titles, chapters or tracks

- ▶ **Input the number of the title, chapter or track you want to play.**
  - Use the number buttons (0 to 9) to input the number, then press **ENTER**.
  - Press **CLEAR** to clear the values you have input.

## Skipping content

- ▶ **Press I◀◀ PREV or ▶▶I NEXT.**
  - When ▶▶I **NEXT** is pressed, the playback skips ahead to the beginning of the next title/chapter/track/file.
  - When I◀◀ **PREV** is pressed, the playback skips back to the beginning of the currently playing title/chapter/track/file. Press twice to skip back to the beginning of the previous title/chapter/track/file.

## Playing in slow motion

- ▶ **While playback is paused, press and hold ◀||/◀| or |||/|▶.**
  - The speed switches each time the button is pressed (the speed is displayed on the TV screen). The speed steps depend on the disc or file.

### ❖ To resume normal playback

- ▶ Press ▶ **PLAY**.

## Step forward and step reverse

- ▶ **While playback is paused, press ◀||/◀| or |||/|▶.**
  - The picture moves a step forward or reverse each time the button is pressed.

### ❖ To resume normal playback

- ▶ Press ▶ **PLAY**.

## Switching the camera angles

For BD-ROM and DVD-Video discs on which multiple angles are recorded, the angles can be switched during playback.

### ▶ **During playback, press ANGLE.**

- The current angle and total number of recorded angles are displayed on the TV screen and on the player's front panel display. To switch the angles, press **ANGLE** again or press ↑/↓.

**Example:**

Current angle/Total number of recorded angles

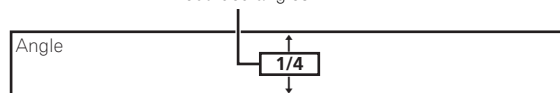

- The angles can also be switched by selecting **Angle** from the **TOOLS** menu.
- If the angles are not switched when **ANGLE** is pressed, switch them from the menu screen.

## Switching the subtitles

For discs on which multiple subtitles are recorded, the subtitles can be switched during playback.

### ⚠ **Caution**

- The subtitles cannot be switched for discs recorded on a DVD or BD recorder. Also refer to the operating instructions of the device used for recording.
- ▶ **During playback, press SUBTITLE.**
  - The current subtitle and total number of recorded subtitles are displayed on the TV screen and on the player's front panel display. To switch the subtitle, press **SUBTITLE** again or press ↑/↓.

**Example:**

Current subtitle/Total number of recorded subtitles

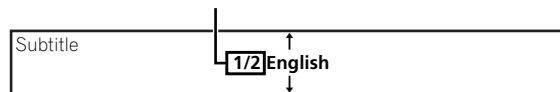

- The subtitles can also be switched by selecting **Subtitle** from the **TOOLS** menu.
- If the subtitles are not switched when **SUBTITLE** is pressed, switch them from the menu screen.

### ❖ **Turning the subtitles off**

- ▶ Press **SUBTITLE**, then press **CLEAR**.

## Switching the audio and secondary audio

For discs or files on which multiple audio streams/channels are recorded, audio streams/channels can be switched during playback. Also use this procedure to switch the secondary audio for BD-ROMs on which secondary audio is recorded.

### ► During playback, press **AUDIO**.

- The current audio and total number of recorded audio streams are displayed on the TV screen and on the player's front panel display.

To switch the audio, press **AUDIO** again or press **↑/↓**.

- To switch the secondary audio, press **SECONDARY AUDIO**.

**Example:** Current audio/Total number of recorded audio streams

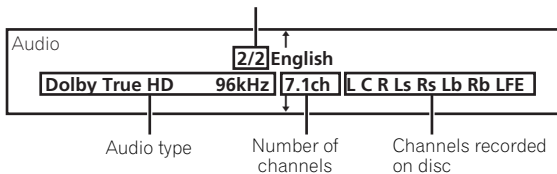

- The audio/secondary audio can also be switched by selecting **Audio** or **Secondary Audio** from the **TOOLS** menu.
- If the audio/secondary audio is not switched when **AUDIO/SECONDARY AUDIO** is pressed, switch it from the menu screen.

### ❖ Turning the Secondary Audio off

- Press **SECONDARY AUDIO**, then press **CLEAR**.

## Switching the secondary video

Use the procedure below to switch the secondary video (Picture-in-Picture) recorded on the BD-ROM.

### ► During playback, press **SECONDARY VIDEO**.

- The current secondary video and total number of recorded secondary video streams are displayed on the TV screen and on the player's front panel display.

To switch the secondary video, press **SECONDARY VIDEO** again or press **↑/↓**.

**Example:** Current secondary video/Total number of recorded secondary video streams

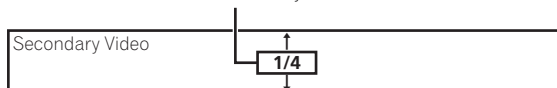

- The secondary video can also be switched by selecting **Secondary Video** from the **TOOLS** menu.
- If the secondary video is not switched when **SECONDARY VIDEO** is pressed, switch it from the menu screen.

### ❖ Turning the Secondary Video off

- Press **SECONDARY VIDEO**, then press **CLEAR**.

## Displaying the disc information

### ► Press **DISPLAY**.



The disc information appears on the TV screen. The information switches each time the button is pressed.

The information display differs during playback and when playback is stopped.

## Playback functions

The functions that can be used differ according to the type of disc and file. In some cases, some of the functions cannot be used. Check the usable functions on the table below.

Function <sup>1</sup>	Disc/file type							
	BD-ROM	BD-R /-RE	DVD-Video	DVD-R /-RW (VR format)	AVCHD	Image file	Audio file	Audio CD
Forward and reverse scanning <sup>2</sup>	✓ <sup>3</sup>	✓ <sup>3</sup>	✓ <sup>3</sup>	✓ <sup>3</sup>	✓ <sup>3</sup>	X	✓ <sup>4</sup>	✓ <sup>4</sup>
Playing specific titles, chapters or tracks	✓	✓	✓	✓	✓	X	X	✓
Skipping content	✓	✓	✓	✓	✓	✓	✓	✓
Playing in slow motion <sup>2,5</sup>	✓	✓	✓	✓	✓	X	X	X
Step forward and step reverse <sup>2</sup>	✓	✓	✓	✓	✓	X	X	X
Switching the camera angles <sup>6</sup>	✓	X	✓	X	X	X	X	X
Switching the subtitles <sup>7</sup>	✓	✓	✓	✓	✓	X	X	X
Switching the audio <sup>8</sup>	✓	✓	✓	✓	✓	X	X	✓
Switching the secondary audio <sup>9</sup>	✓ <sup>10</sup>	X	X	X	X	X	X	X
Switching the secondary video <sup>11</sup>	✓ <sup>12</sup>	X	X	X	X	X	X	X
Displaying the disc information	✓	✓	✓	✓	✓	✓	X	X

- Some functions may not work for some discs or files, even if indicated [✓] on the table.
- For some discs, normal playback resumes automatically when the chapter switches.
- No sound is produced during forward and reverse scanning.
- Sound is produced during forward and reverse scanning.
- No sound is output during slow motion playback.
  - It is not possible to switch the speed during reverse slow motion playback.
- Angle mark  is displayed for scenes at which multiple angles are recorded if **Angle/Secondary Indicator** is set to **On** (page 45).
- The types of recorded subtitles depend on the disc and file.
  - In some cases the subtitle may switch or the switching screen provided on the disc may be displayed immediately, without the current subtitle or the total number of subtitles recorded on the disc being displayed.
- The types of recorded audio streams depend on the disc and file.
- The types of recorded secondary audio streams depend on the disc and file.
  - In some cases the secondary audio may switch or the switching screen provided on the disc may be displayed immediately, without the current secondary audio or the total number of secondary audio streams recorded on the disc being displayed.
  - Secondary audio mark  is displayed for scenes at which secondary audio is recorded if **Angle/Secondary Indicator** is set to **On** (page 45).
- Some discs do not include secondary audio.
- In some cases the secondary video may switch or the switching screen provided on the disc may be displayed immediately, without the current secondary video or the total number of secondary video streams recorded on the disc being displayed.
  - Secondary video mark  is displayed for scenes at which secondary video is recorded if **Angle/Secondary Indicator** is set to **On** (page 45).
- Some discs do not include secondary video.



# Using the Play Mode functions

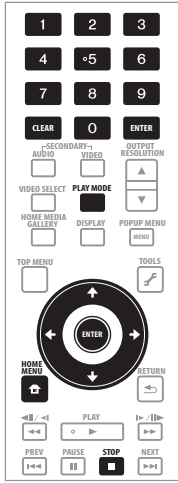

## Playing from a specific time (Time Search)

**1** During playback, press **PLAY MODE** to display the **Play Mode** screen.

The Play Mode screen can also be displayed by selecting **Play Mode** from the **TOOLS** menu.

**2** Select **Time Search**.

Use **↑/↓** to select, then press **ENTER**.

**3** Input the time.

Use the number buttons (0 to 9) or **↑/↓** to input the time. Use **←/→** to move the cursor.

- To play from 45 minutes, input **0, 0, 4, 5, 0** and **0**, then press **ENTER**.
- To play from 1 hour 20 minutes, input **0, 1, 2, 0, 0** and **0**, then press **ENTER**.
- Press **CLEAR** to clear the values you have input.



**4** Starting playback from the specified time.

Use **←/→** to select **Search**, then press **ENTER**.

### ❖ Closing the Play Mode screen

Press **PLAY MODE** or **HOME MENU**.

## Playing a specific title, chapter or track (Search)

**1** Press **PLAY MODE** to display the **Play Mode** screen.

The Play Mode screen can also be displayed by selecting **Play Mode** from the **TOOLS** menu.

**2** Select the type of search.

Use **↑/↓** to select, then press **ENTER**.

See the table on page 35 for the search types.

**3** Input the number.

Use the number buttons (0 to 9) or **↑/↓** to input the number.

Use **←/→** to move the cursor.

- To search for title 32, input **0, 3** and **2**, then press **ENTER**.
- Press **CLEAR** to clear the values you have input.



**4** Starting playback from the specified title, chapter or track.

Use **←/→** to select **Search**, then press **ENTER**.

## Playing a specific section within a title or track repeatedly (A-B Repeat)

Use this procedure to play a specific section within a title or track repeatedly.

**1** During playback, press **PLAY MODE** to display the **Play Mode** screen.

The Play Mode screen can also be displayed by selecting **Play Mode** from the **TOOLS** menu.

**2** Select **A-B Repeat**.

Use **↑/↓** to select, then press **ENTER**.

**3** Select the starting point for A-B Repeat.

Use **←/→** to select **A (Start)**, then press **ENTER**.



**4** Select the end point for A-B Repeat.

Use **←/→** to select **B (End)**, then press **ENTER**.

A-B Repeat playback starts.

### ❖ To cancel A-B Repeat play

- Select **Off** from the Repeat/Random screen, then press **ENTER**.
- During playback, press **STOP** or **CLEAR**.

 **Note**

- A-B Repeat play is canceled in the following cases:
  - When the angle is switched (for BD-ROM and DVD-Video discs only).
  - When you search outside the repeat range.
  - When you start other Repeat Play or Random Play.

## Playing repeatedly (Repeat Play)

---

Use this procedure to play the currently playing disc, title, chapter, track or file repeatedly.

### 1 During playback, press **PLAY MODE** to display the **Play Mode** screen.

The Play Mode screen can also be displayed by selecting **Play Mode** from the **TOOLS** menu.

### 2 Select Repeat/Random.

Use **↑/↓** to select, then press **ENTER**.

### 3 Select the type of Repeat Play.

Use **↑/↓** to select, then press **ENTER**.

See the table on page 35 for the types of Repeat Play.

### ❖ To cancel Repeat Play

- Select **Off** from the Repeat/Random screen, then press **ENTER**.
- During playback, press **■ STOP** or **CLEAR**.

 **Note**

- The type of repeat modes depends on the disc and file being played. See the table on page 35.
- Repeat Play is canceled in the following cases:
  - When the angle is switched (for BD-ROM and DVD-Video discs only).
  - When you search outside the repeat range.
  - When you start other Repeat Play or Random Play.

## Playing in random order (Random Play)

---

Use this procedure to play the tracks or files in random order.

### 1 During playback, press **PLAY MODE** to display the **Play Mode** screen.

The Play Mode screen can also be displayed by selecting **Play Mode** from the **TOOLS** menu.

### 2 Select Repeat/Random.

Use **↑/↓** to select, then press **ENTER**.

### 3 Select the Random Play.

Use **↑/↓** to select, then press **ENTER**.

### ❖ To cancel Random Play

- Select **Off** from the Repeat/Random screen, then press **ENTER**.



- During playback, press **■ STOP** or **CLEAR**.

 **Note**

- Random Play is canceled in the following cases:
  - When you use the search function.
  - When you start Repeat Play.

## About Play Mode types

The functions that can be used differ according to the type of disc and file. In some cases, some of the functions cannot be used. Check the usable functions on the table below.

Play Mode type	Mark <sup>1</sup>	Disc/file type								
		BD-ROM <sup>2</sup>	BD-R /-RE	DVD-Video <sup>2</sup>	DVD-R /-RW (VR format)	AVCHD	Image file	Audio file	Audio CD	
Repeat Play	Playing a specific section within a title or track repeatedly (A-B Repeat)	A-B	✓	✓	✓	✓	✓	✗	✗	✓
	Playing a title repeatedly (Title Repeat)		✓	✓	✓	✓	✓	✗	✗	✗
	Playing a chapter repeatedly (Chapter Repeat)		✓	✓	✓	✓	✓	✗	✗	✗
	Playing a track or file repeatedly (Track Repeat)		✗	✗	✗	✗	✗	✗	✓	✓
	Playing all the titles, tracks or files on the disc repeatedly (All Repeat)		✗	✓	✗	✓ <sup>3</sup>	✗	✓ <sup>4</sup>	✓ <sup>5</sup>	✓ <sup>6</sup>
Random Play	Playing the tracks or files in random order (Random Track/File)	RDM	✗	✗	✗	✗	✗	✓	✓	✓
Search	Playing from a specific time (Time Search)	—	✓	✓	✓	✓	✓	✗	✗	✓
	Playing a specific title (Title Search)	—	✓	✓	✓	✓	✓	✗	✗	✗
	Playing a specific chapter (Chapter Search)	—	✓	✓	✓	✓	✓	✗	✗	✗
	Playing a specific track (Track Search)	—	✗	✗	✗	✗	✗	✗	✗	✓

1. The type of Play Mode is indicated by the mark.

2. For BD-ROM and DVD-Video discs, some of the functions cannot be used with some titles.

3. The original titles are played repeatedly. However, the playlist titles cannot be played repeatedly.

4. The files in the folder are played repeatedly.

5. The files in the folder or HMG Playlist are played repeatedly.

6. The tracks in the disc or HMG Playlist are played repeatedly.

# Playing from the Home Media Gallery

The Home Media Gallery lets you display a list of the titles, tracks or files recorded on the disc. The discs that can be played from the Home Media Gallery are as shown below (see also page 8).

- BD-R/-RE discs
- DVD-R/-RW (VR format) discs
- Audio CDs (CD-DAs and DTS-CDs)
- DVDs/CDs on which only data files of image or audio files, etc. are recorded

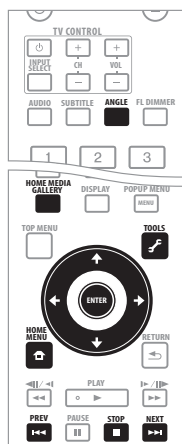

## Playing discs

### 1 Press HOME MEDIA GALLERY to display the Home Media Gallery.

The Home Media Gallery can also be displayed by selecting **Home Media Gallery** from the Home Menu then pressing **ENTER**.

### 2 Select the disc.

Use **↑/↓** to select, then press **ENTER**.

### 3 Select the title or track to be played.

Use **↑/↓** to select, then press **ENTER**.

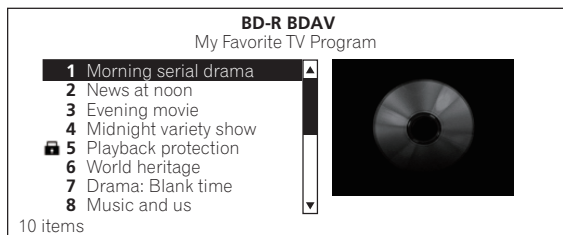

Playback starts.

### ❖ Closing the Home Media Gallery

Press **HOME MEDIA GALLERY** or **HOME MENU**.

### ✎ Note

- When playing an audio CD (CD-DA or DTS-CD), the Now Playing screen is displayed.
- Some BD-R/-RE discs have playback protection. To cancel the protection, input the password set for the disc.
- To play DVD-R/-RW (VR format) playlists, switch to the playlist using the **Original/Play List** command on the **TOOLS** menu (page 26).

## Playing image files

### 1 Press HOME MEDIA GALLERY to display the Home Media Gallery.

The Home Media Gallery can also be displayed by selecting **Home Media Gallery** from the Home Menu then pressing **ENTER**.

### 2 Select the disc.

Use **↑/↓** to select, then press **ENTER**.

### 3 Select Photos.

Use **↑/↓** to select **Photos**, then press **ENTER**.

### 4 Select Folders or All Photos.

Use **↑/↓** to select, then press **ENTER**.

- **Folders** – The files in the selected folder are displayed.
- **All Photos** – All the recorded files are displayed.

If you have selected **All Photos**, proceed to step 6.

### 5 Select the folder containing the file you want to play.

Use **↑/↓/←/→** to select, then press **ENTER**.

A list of the files and folders in the selected folder is displayed.

### 6 Select and set the file you want to play.

Use **↑/↓/←/→** to select, then press **ENTER**.

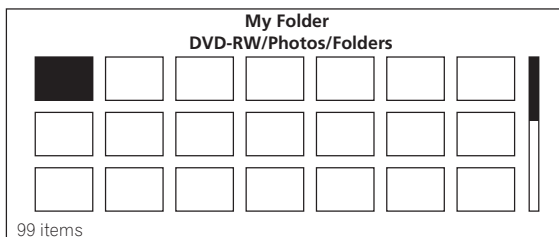

A slideshow starts from the selected file, and continues until the end of the list is reached.

### ❖ About Slideshow

A display of the files on the disc or in the folder that switches automatically. Use **◀◀/▶▶** to display the previous or next file.

## ❖ Rotating images

- ▶ Press **ANGLE** while playing a slideshow.
- The image rotates each time the button is pressed (90° → 180° → 270° → 0° → ...).

The image can also be rotated by selecting **Rotate** from the **TOOLS** menu.

## Playing audio files

### 1 Press HOME MEDIA GALLERY to display the Home Media Gallery.

The Home Media Gallery can also be displayed by selecting **Home Media Gallery** from the Home Menu then pressing **ENTER**.

### 2 Select the disc.

Use **↑/↓** to select, then press **ENTER**.

### 3 Select Music.

Use **↑/↓** to select **Music**, then press **ENTER**.

### 4 Select Folders or All Songs.

Use **↑/↓** to select, then press **ENTER**.

- **Folders** – The files in the selected folder are displayed.
- **All Songs** – All the recorded files are displayed.

If you have selected **All Songs**, proceed to step 6.

### 5 Select the folder containing the file you want to play.

Use **↑/↓** to select, then press **ENTER**.

A list of the files and folders in the selected folder is displayed.

### 6 Select and set the file you want to play.

Use **↑/↓** to select, then press **ENTER**.

Playback starts from the selected file, and continues until the end of the list is reached. Use **◀◀/▶▶** to play the previous or next file. The Now Playing screen (shown below) is displayed.

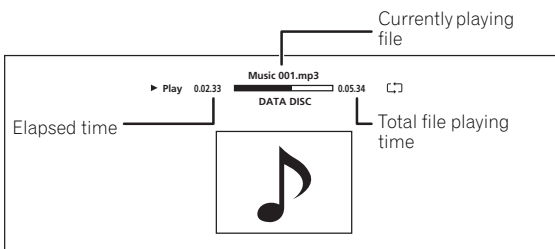

## Playing in the desired order (HMG Playlist)

The discs that can add tracks and files to the HMG (Home Media Gallery) Playlist are as shown below.

- Audio CDs (CD-DAs and DTS-CDs)
- DVDs/CDs on which audio files are recorded

## ❖ Adding tracks/files

Use this procedure to add tracks and files, and create the HMG Playlist.

### 1 Press HOME MEDIA GALLERY to display the Home Media Gallery.

The Home Media Gallery can also be displayed by selecting **Home Media Gallery** from the Home Menu pressing **ENTER**.

### 2 Select the disc.

Load the disc beforehand.

Use **↑/↓** to select, then press **ENTER**.

### 3 Select the track/file to be added.

Use **↑/↓** to select.

### 4 Press **TOOLS** to display the TOOLS menu.

### 5 Select Add to HMG Playlist.

Use **↑/↓** to select, then press **ENTER**.

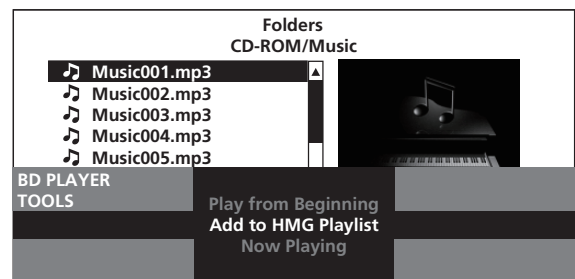

The track or file selected in step 3 is added to the HMG Playlist. To add more tracks or files, repeat steps 3 to 5.

## ❖ To add the currently playing track/file to the HMG Playlist

### 1 While the track/file is playing, press **TOOLS** to display the TOOLS menu.

### 2 Use **↑/↓** to select Add to HMG Playlist, then press **ENTER**.

#### Note

- A maximum of 24 tracks/files can be added to the HMG Playlist.
- The HMG Playlist is cleared in the following cases:
  - When the power is turned off.
  - When the disc tray is opened.

## ❖ Playing the HMG Playlist

### 1 Press HOME MEDIA GALLERY to display the Home Media Gallery.

The Home Media Gallery can also be displayed by selecting **Home Media Gallery** from the Home Menu pressing **ENTER**.

### 2 Select HMG Playlist.

Use **↑/↓** to select, then press **ENTER**.

### 3 Select the track/file to be played.

Use **↑/↓** to select, then press **ENTER**.

Playback starts from the selected track/file, and continues until the end of the list is reached. Use **⏮**/**⏭** to play the previous or next track/file. The Now Playing screen (shown below) is displayed.

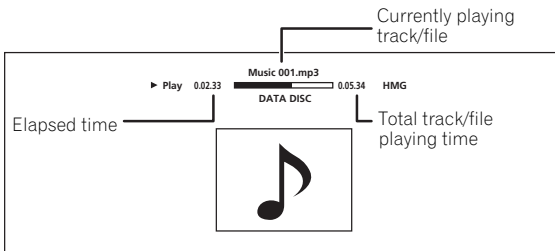

## ❖ Deleting tracks/files from the HMG Playlist

### 1 Select the track/file to be deleted, then press **⚙** TOOLS to display the TOOLS menu.

### 2 Use **↑/↓** to select Delete from HMG Playlist, then press **ENTER**.

## Chapter 6

# Adjusting audio and video

## Adjusting the video

The quality of the playback picture can be adjusted according to the TV you are using.

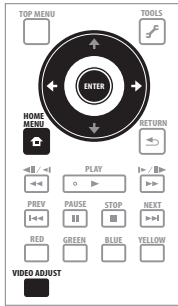

### 1 During playback, press VIDEO ADJUST to display the Video Adjust screen.

The Video Adjust screen can also be displayed by selecting **Video Adjust** from the **TOOLS** menu.

### 2 Select a preset.

Select using  $\leftarrow/\rightarrow$  according to the TV being used.



- **Pioneer PDP** – Select this when connected to a Pioneer plasma TV.
- **Pioneer LCD** – Select this when connected to a Pioneer liquid crystal display TV.
- **Pioneer Projector** – Select this when connected to a Pioneer front projector.
- **PDP** – Select this when connected to a plasma TV of another brand.
- **LCD** – Select this when connected to a liquid crystal display of another brand.
- **Projector** – Select this when connected to a front projector of another brand.
- **Professional** – With this setting, video signal processing is restrained. Select this when connected to a professional monitor.
- **Memory1 to 3** – Picture quality settings with adjusted parameters can be stored in the memory. For a description of the parameters, see *When Memory1, 2 or 3 is selected* below.

### ❖ When Memory1, 2 or 3 is selected

#### 1 Select Adjustments.

Use  $\downarrow$  to select **Adjustments**, then press **ENTER**.

A detailed settings screen appears.

### 2 Select the item to be adjusted.

Use  $\uparrow/\downarrow$  to select.

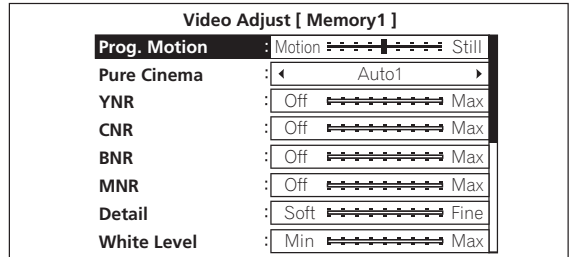

### 3 Adjust the picture quality.

When  $\leftarrow/\rightarrow$  are pressed, the adjustments can be made viewing the picture. The detailed settings screen reappears when **ENTER** is pressed.



- **Prog.Motion** – Adjust according to the type of image (moving or still image). This is effective mainly when outputting video materials as progressive images.
- **Pure Cinema** – This setting optimizes the operation of the progressive scanning circuit for playing film materials. Normally set it to **Auto1**. If the picture seems unnatural, switch this to **Auto 2**, **On** or **Off** (page 40).
- **YNR** – Reduces noise in the luminance (Y) signal.
- **CNR** – Reduces noise in the chroma (C) signal.
- **BNR** – Reduces the block noise (block-shaped distortion generated upon MPEG compression).
- **MNR** – Reduces the mosquito noise (distortion along the contours of the picture generated upon MPEG compression).
- **Detail** – Adjusts the picture's contours.
- **White Level** – Adjusts the level of the white portions.
- **Black Level** – Adjusts the level of the black portions.
- **Black Setup** – Select the black level as the setup level. Normally select **7.5 IRE**. If the black level is too bright due to the combination with the connected TV, select **0 IRE**.
- **Gamma Correction** – Adjusts how the dark portions of the picture look.
- **Hue** – Adjusts the balance between green and red.
- **Chroma Level** – Adjusts the density of the colors.

### Note

- **Prog.Motion** and **Pure Cinema** have the effect only for pictures recorded in the interlaced scan format (480i or 1080i signals).

- **Prog.Motion** is disabled when **Pure Cinema** is set to **On**.
- **Black Setup** has the effect only for pictures output from the **VIDEO** output terminals and signals output with a frame/field frequency of 60Hz.
- **YNR, CNR, BNR** and **MNR** have no effect on 1080/24p video signals output from the **HDMI OUT** terminal.

### ❖ Closing the Video Adjust screen

Press  **HOME MENU**.

### ❖ About Pure Cinema

There are two types of video signals:

- **Video material** – Video signals recorded at 25 or 30 frames/second
- **Film material** – Video signals recorded at 24 frames/second

“Pure Cinema” uses signal processing suited for “film material” when converting 480i/576i or 1080i interlaced video signals into progressive video signals, resulting in clear picture reproduction without losing the quality of the material.

 is displayed on the disc information screen when playing the “film material” pictures of BD-ROM, BD-R/-RE and DVD-Video discs (page 31).

## Adjusting the audio

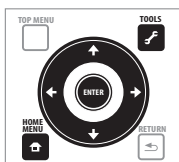

### Adjusting the Audio DRC

Audio DRC (Dynamic Range Control) has the effect of playing loud sounds softly and soft sounds loudly. Adjust the setting for example when viewing movies late at night and the dialogs are difficult to hear.

#### 1 During playback, display the TOOLS menu.

Press  **TOOLS**.

#### 2 Select and set Audio Adjust.

Use  to select, then press **ENTER**.

#### 3 Select and set Audio DRC.

Use  to select, then press **ENTER**.

#### 4 Adjust the setting.

Use  to switch between **Off**, **Low**, **Medium**, **High** and **Auto**.

### ❖ Closing the Audio DRC screen

Press **ENTER** or  **HOME MENU**.

### Note

- This only affects the Dolby TrueHD, Dolby Digital Plus and Dolby Digital audio signals of BDs and DVDs.
- When **Auto** is selected, the setting has the same effect as **High** or **Off** for Dolby TrueHD signals, depending on the content. For Dolby Digital Plus and Dolby Digital, the setting has the same effect as **Off**.
- Audio DRC affects the audio signals output from the following audio output terminals:
  - Analog audio signals output from the **AUDIO OUT** terminals.
  - Linear PCM audio signals output from the **DIGITAL OUT** terminal or **HDMI OUT** terminal.
- The effect may be weak for some discs.

## Adjusting the output level of the different speakers during BD/DVD playback (Channel Level)

### Caution

- **Channel Level** of the speakers set to **None** or **No** at **Speaker Setup** cannot be adjusted (page 47).

#### 1 During playback, display the TOOLS menu.

Press  **TOOLS**.

#### 2 Select and set Audio Adjust.

Use  to select, then press **ENTER**.

#### 3 Select and set Channel Level.

Use  to select, then press **ENTER**.

#### 4 Adjust the output level.

Use  to select,  to adjust.

The output levels of the **L**, **C**, **R**, **SL**, **SR**, **SBL**, **SBR** and **SW** speakers can be adjusted within the range of  $-6.0$  dB to  $+6.0$  dB.

L	< 0.0 dB >
C	0.0 dB
R	0.0 dB
SR	0.0 dB
SBR	0.0 dB
SBL	0.0 dB
SL	0.0 dB
SW	0.0 dB

#### 5 Press ENTER to set.

### Note

- The adjustment of **Channel Level** is only applicable to the sound output from **AUDIO OUT**.
- This cannot be adjusted when in the following cases:
  - **Output Terminal** is set to **HDMI** or **DIGITAL AUDIO** (page 51).
  - **Audio Output Mode** is set to **2 Channel** (page 43).



– **Channel Level** is set to **Fix** (page 43).

## ❖ Closing the Channel Level screen

Press  **HOME MENU**.

## Adjusting the audio delay (Lip Sync)

Adjust the audio delay for the selected video output terminal if the video and audio are not synchronized.

### 1 During playback, display the TOOLS menu.

Press  **TOOLS**.

### 2 Select and set Audio Adjust.

Use **↑/↓** to select, then press **ENTER**.

### 3 Select and set Lip Sync.

Use **↑/↓** to select, then press **ENTER**.

### 4 Select Auto or Manual.

Use **←/→** to select.

- **Auto** – The player automatically adjusts the timing of the video and audio when connected to a device equipped with the HDMI Auto Lipsync Correction feature using an HDMI cable.
- **Manual** – Adjust manually while viewing the video.

If you have selected **Manual**, proceed to step 5.

### 5 Adjusting the amount of audio delay.

Press **↓**, then use **←/→** to adjust.

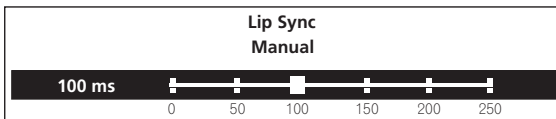

The audio delay can be adjusted from 0 to 250 ms in steps of 5 ms.



#### Note

- The **Lip Sync** adjustment is only applicable to the output terminal set at **Output Terminal** (page 51).
- The sound may be interrupted while setting the delay.

## ❖ Closing the Lip Sync screen

Press **ENTER** or  **HOME MENU**.

# Detailed settings

## Changing the settings

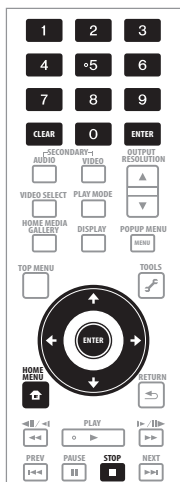

## Operating the Initial Setup screen

**1 When playback is stopped, display the Home Menu screen.**

Press HOME MENU.

**2 Select and set Initial Setup.**

Use / to select, then press ENTER.

**3 Select the item and change the setting.**

Use /// to select, then press ENTER.

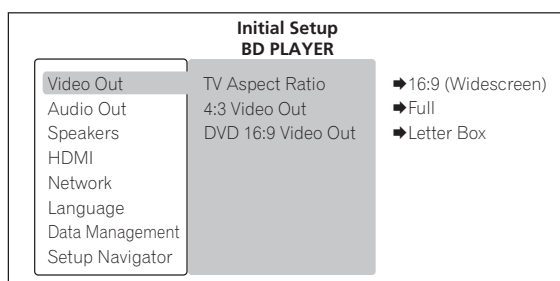

### ❖ Closing the Initial Setup screen

Press HOME MENU.



#### Note

- Items that cannot be changed are indicated in gray. The items that can be selected depend on the player's status.
- In Options, the factory default settings are indicated in bold.

Setting	Options	Explanation
Video Out	<b>16:9 (Widescreen)</b>	Select this when connected to a wide (16:9) TV.
	4:3 (Standard)	Select this when connected to a conventional TV.
4:3 Video Out	<b>Full</b>	4:3 pictures are displayed over the entire screen.
	Normal	4:3 pictures are displayed with vertical black bars along the sides. Select this when you cannot switch the aspect ratio to 4:3 on the TV.
<b>4:3 Video Out</b> is only valid when <b>TV Aspect Ratio</b> is set to <b>16:9 (Widescreen)</b> .		
DVD 16:9 Video Out	<b>Letter Box</b>	16:9 pictures are displayed with black bars at the top and bottom when viewing on a 4:3 screen.
	Pan & Scan	The picture is displayed over the entire screen, with the left and right sides of the 16:9 picture cropped. Select this to view 4:3 pictures over the entire screen. For some discs, the picture will be displayed in the <b>Letter Box</b> mode even if <b>Pan &amp; Scan</b> is set.
<ul style="list-style-type: none"> <li>• <b>DVD 16:9 Video Out</b> is only valid when <b>TV Aspect Ratio</b> is set to <b>4:3 (Standard)</b>.</li> <li>• <b>DVD 16:9 Video Out</b> is only valid when playing 16:9 pictures of DVD-Video or DVD-R/-RW (VR format) discs. When other 16:9 pictures are played, they are output in the <b>Letter Box</b> mode.</li> </ul>		

Setting	Options	Explanation
Video Out NTSC on PAL TV	On	Select this when a TV that only supports PAL is connected. The picture is displayed correctly when playing a disc recorded with a frame/field rate other than 50 Hz.
	<b>Off</b>	Select this when connected to an NTSC-compatible TV.
<ul style="list-style-type: none"> <li>Many recent PAL TVs support the input of NTSC signals, in which case this can be set to <b>Off</b>. Also check your TV's operating instructions.</li> </ul>		
Audio Out Dolby Digital Out * Only valid for the <b>DIGITAL OUT</b> terminal.	<b>Dolby Digital 1</b>	Dolby Digital audio signals are output. With BD-ROMs, the secondary audio and interactive audio are mixed for output.
	Dolby Digital 2	Dolby Digital audio signals are output. With BD-ROMs, the signals are output without mixing the secondary audio and interactive audio signals.
	Dolby Digital → PCM	Select this when the connected AV receiver or amplifier, etc., is not compatible with Dolby Digital audio signals. The Dolby Digital audio signals are converted into linear PCM audio signals for output.
DTS Out * Only valid for the <b>DIGITAL OUT</b> terminal.	<b>DTS 1</b>	DTS Digital Surround audio signals are output. With BD-ROMs, the secondary audio and interactive audio are mixed for output.
	DTS 2	DTS Digital Surround audio signals are output. With BD-ROMs, the signals are output without mixing the secondary audio and interactive audio signals.
	DTS → PCM	Select this when the connected AV receiver or amplifier, etc., is not compatible with DTS Digital Surround audio signals. The DTS Digital Surround audio signals are converted into linear PCM audio signals for output.
AAC Out * Only valid for the <b>DIGITAL OUT</b> terminal.	AAC	Select this when the connected AV receiver or amplifier, etc., is compatible with AAC audio signals. The AAC audio signals are output.
	<b>AAC → PCM</b>	Select this when the connected AV receiver or amplifier, etc., is not compatible with AAC audio signals. The AAC audio signals are converted into linear PCM audio signals for output.
DTS Downmix	<b>Stereo</b>	DTS-HD Master Audio signals, DTS-HD High Resolution Audio signals or DTS Digital Surround audio signals converted to linear PCM audio signals are converted into 2-channel (stereo) signals for output.
	Lt/Rt	DTS-HD Master Audio signals, DTS-HD High Resolution Audio signals or DTS Digital Surround audio signals converted to linear PCM audio signals are converted into 2-channel signals compatible with Dolby Surround for output (when the connected AV receiver or amplifier, etc., is compatible with Dolby Pro Logic, the AV receiver or amplifier outputs the linear PCM audio signals as surround audio signals).
Speakers Audio Output Mode * Only valid for the <b>AUDIO OUT</b> terminals.	<b>2 Channel</b>	Select this when the TV's analog 2-channel (stereo) audio input terminals are connected to the player's <b>AUDIO OUT</b> terminals.
	Multi-channel	Select this when the multi-channel audio input terminals of an AV receiver or amplifier, etc., are connected to the player's <b>AUDIO OUT</b> terminals.
Speaker Setup * Only valid for the <b>AUDIO OUT</b> terminals.	When an AV receiver or amplifier, etc., is connected to the player's <b>AUDIO OUT</b> terminals, set whether or not speakers are connected to an AV receiver or amplifier, etc., their size and their crossover frequency. For details, see <i>Changing the speaker setup</i> on page 47.	
Speaker Distance * Only valid for the <b>AUDIO OUT</b> terminals.	Specify the distance of your speakers from your listening position (page 47).	
Channel Level * Only valid for the <b>AUDIO OUT</b> terminals.	<b>Fix</b>	The output for the various speakers is set to the maximum.
	Variable	The output level of the various speakers is set within the range of -6.0 dB to +6.0 dB (in 0.5 dB steps) (page 47).

	Setting	Options	Explanation
HDMI	HDMI High Speed Transmission	On	Select this when connected with a High Speed HDMI™ cable (page 18).
		<b>Off</b>	Select this when connected with a Standard HDMI™ cable (page 18).
The player's setting screen is closed if the output video resolution is switched by changing the <b>HDMI High Speed Transmission</b> setting.			
HDMI	HDMI Color Space	<b>Auto</b>	Select this to automatically switch the video output between YCbCr and RGB signals according to the connected equipment.
		YCbCr 4:4:4	Select this to output the video signals as YCbCr 4:4:4 signals.
		YCbCr 4:2:2	Select this to output the video signals as YCbCr 4:2:2 signals.
		RGB (16 to 235)	Select this to output the video signals as RGB signals. Choose this if the colors seem too dense and all the dark colors are displayed in a uniform black when <b>RGB (0 to 255)</b> is selected.
		RGB (0 to 255)	Select this to output the video signals as RGB signals. Choose this if the colors seem too faint and the black seems too bright when <b>RGB (16 to 235)</b> is selected.
Normally it is recommended to set this to <b>Auto</b> . When set to <b>Auto</b> , the optimum video signals for your TV are output.			
HDMI	HDMI Audio Out	<b>Auto</b>	The signals are output with as many audio channels as possible. In cases when the number of channels does not decrease when the signals are output as such without converting them to linear PCM, they are output as such (page 52).
		PCM	Select this when you want the secondary audio and interactive audio signals to be mixed for output or when you want to output prioritizing sampling frequency over the number of channels (page 52).
		Off	Select this when you do not want to output the audio from the HDMI output terminal.
KURO	LINK	On	Select this to control the player with the remote control of the AV device connected using an HDMI cable. Also refer to <i>About KURO LINK function</i> on page 19.
		<b>Off</b>	Select this when you do not want to control the player with the remote control of the AV device connected using an HDMI cable.
Display	Power On * Only valid when <b>KURO LINK</b> is set to <b>On</b> .	On	Select this when you want the TV to turn on each time playback is started or the Home Menu or Home Media Gallery is displayed on the player.
		<b>Off</b>	Select this when you do not want the TV to turn on each time playback is started or the Home Menu or Home Media Gallery is displayed on the player.
Display	Power Off * Only valid when <b>KURO LINK</b> is set to <b>On</b> .	On	Select this when you want the player's power to turn off together with the TV's power.
		<b>Off</b>	Select this when you do not want the player's power to turn off together with the TV's power.
PQLS	* Only valid when <b>KURO LINK</b> is set to <b>On</b> .	Auto	Enables PQLS function (page 19).
		<b>Off</b>	Disables PQLS function (page 19).
Network	IP Address	Select this to set the IP address of the player and DNS server (page 48).	
	Proxy Server	Only set the proxy server if so instructed by your Internet service provider (page 48).	
	Display Network Configuration	Select this to display a list of the network settings (page 49).	
	Connection Test	Select this to test the network connection (page 49).	
Language	OSD Language	<b>English</b>	Select this to set the language of the on-screen displays to English.
		<i>available languages</i>	Choose a language for the on-screen displays from the listed languages.
	Audio Language * For some discs, it may not be possible to change to the selected language.	<b>English</b>	Select this to set both the BD-ROM and DVD-Video default audio language to English.
		<i>available languages</i>	Choose a language from the listed languages to set the default audio language for BD-ROM and DVD-Video playback.
	Other	Continue to the next screen to set the default audio language for BD-ROM and DVD-Video playback. You can select the language name or enter the code number (see on page 54 for the code table).	
If a language not recorded on the BD/DVD is set, one of the recorded languages is automatically selected and played.			

Setting	Options	Explanation
Language	Subtitle Language	<b>English</b> Select this to set the default subtitle language for BD-ROM and DVD-Video playback to English.
	* For some discs, it may not be possible to change to the selected language.	<i>available languages</i> Choose a language from the listed languages to set the default subtitle language for BD-ROM and DVD-Video playback.
		Other Continue to the next screen to set the default subtitle language for BD-ROM and DVD-Video playback. You can select the language name or enter the code number (see on page 54 for the code table).
	If a language not recorded on the BD/DVD is set, one of the recorded languages is automatically selected and played.	
BDMV/DVD-Video Menu Lang.	<b>w/Subtitle Language</b>	Sets the language of BD-ROM and DVD-Video menus to the same as that set for the subtitle language.
	* For some discs, it may not be possible to change to the selected language.	<i>available languages</i> Choose a language from the listed languages to set the default language for BD-ROM and DVD-Video menus.
		Other Continue to the next screen to set the default menu language for BD-ROM and DVD-Video menus. You can select the language name or enter the code number (see on page 54 for the code table).
	If a language not recorded on the BD/DVD is set, one of the recorded languages is automatically selected and played.	
Subtitle Display	<b>On</b>	Select this to display the subtitles.
	<b>Off</b>	Select this if you do not want to display the subtitles. Note that on some discs the subtitles are displayed by force.
Data Management	Individual/Shared Data Erase	Use this to display the list of data used for the BD-LIVE and BONUSVIEW functions and to erase the data (page 49).
	Remove the disc from the disc tray when changing the setting.	
	Application Data Erase	Use this to erase bookmarks, high scores of games and other data (page 49).
	Remove the disc from the disc tray when changing the setting.	
	Storage Format	Select this to format the storage device on which the data used by the BD-LIVE and BONUSVIEW functions is stored (page 49).
Remove the disc from the disc tray when changing the setting.		
Setup Navigator	Start making the settings using the Setup Navigator menu. For details, see <i>Making settings using the Setup Navigator menu</i> on page 23.	
Playback	Still Picture	Field This eliminates instability of the picture when playback is paused.
		Frame This makes pictures clear when playback is paused, but instability may be observed.
		<b>Auto</b> <b>Field</b> or <b>Frame</b> is switched automatically according to the disc or file being played.
Angle/Secondary Indicator	<b>On</b>	Select this to display the angle mark, secondary video mark and secondary audio mark on the TV screen (pages 30 and 31).
	<b>Off</b>	Select this if you do not want to display the angle mark, secondary video mark and secondary audio mark on the TV screen.
Hybrid Disc Playback	<b>BD</b>	The BD layer of hybrid discs with two or more layers (BD and DVD or CD) is played.
	DVD	The DVD layer of hybrid discs with two or more layers (BD and DVD) is played. If there is no DVD layer, the BD layer is played.
	CD	The CD layer of hybrid discs with two or more layers (BD and CD) is played. If there is no CD layer, the BD layer is played.
Remove the disc from the disc tray when changing the setting.		
BDMV/BDAV Playback Priority	<b>BDMV</b>	Select this to play the BDMV format on BD-R/-RE discs containing both BDMV and BDAV formats.
	<b>BDAV</b>	Select this to play the BDAV format on BD-R/-RE discs containing both BDMV and BDAV formats.
Remove the disc from the disc tray when changing the setting.		

	Setting	Options	Explanation	
Parental Lock	Set Password (Change Password)		Register (change) the password for parental lock settings or for unlocking to play DVD-Video with parental lock feature (page 50).	
	DVD-Video Parental Lock		Change the player's parental lock level (page 50).	
	BDMV Parental Lock		Change the restricted age (page 50).	
	Country Code		Change the Country/Area code (page 50).	
Options	Output Terminal		Set the terminals from which the player's video and audio signals are to be output (page 51).	
	On Screen Display	On	Select this to display the operation indicators (Play, Stop, etc.) on the TV screen.	
		<b>Off</b>	Select this if you do not want to display the operation indicators (Play, Stop, etc.) on the TV screen.	
	Screen Saver	On		The black screen (the screen saver) is displayed, if there is no operation for over 1 minute after playback is stopped or paused. The screen saver is automatically activated if there is no operation for over 1 minute after the Home Menu or Home Media Gallery is displayed while playing a BD or DVD. With audio CDs and audio files, the screen saver is automatically activated if no button is operated for over 1 minute, even while the audio CD or audio file is playing. The screen saver turns off when an operation is performed on the player or remote control.
			<b>Off</b>	The screen saver is not activated.
	Auto Power Off	On		Select this to turn the power off automatically (the power turns off automatically if no operation is performed for over 30 minutes).
<b>Off</b>			Select this if you do not want the power to turn off automatically.	
Software Update			The Software Update function can check for and download updated system software from the network server (page 51).	
Advanced Setup			Use this to make advanced settings (page 55).	

## ❖ Changing the speaker setup

Set whether or not speakers are connected to an AV receiver or amplifier, etc., their size and their crossover frequency. This setting is only valid for the **AUDIO OUT** terminals.

When there are no speakers whose speaker size is set to **Small**, select **Bypass** for the crossover frequency.

When there are speakers whose speaker size is set to **Small**, select the crossover frequency (**Bypass** cannot be selected).

### ⚠ Caution

- The **Speaker Setup** cannot be selected when **Audio Output Mode** is set to **2 Channel**. Change the setting to **Multi-channel** (page 43).

#### 1 Select and set Speakers → Speaker Setup → Next Screen.

Use **↑/↓** to select, then press **ENTER**.

#### 2 Select the speaker and change the setting.

Use **↑/↓** to select, then use **←/→** to change the setting.

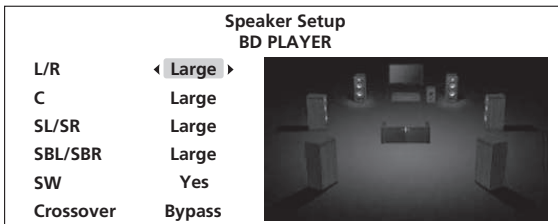

- L/R** (front left and right speakers): **Large/Small**
- C** (center speaker): **Large/Small/None**
- SL/SR** (left and right surround speakers): **Large/Small/None**
- SBL/SBR** (left and right surround back speakers): **Large/Small/None**
- SW** (subwoofer): **Yes/No**
- Crossover**: **Bypass/50 Hz/80 Hz/100 Hz/150 Hz**

### 📝 Note

- Depending on the combination of settings of the different speakers, the settings of speakers other than the one you have changed may also change automatically.
- When a subwoofer with a filter bypass function is connected and there is no speaker whose speaker size is set to **Small**, if the subwoofer's filter is set to be bypassed, the player's high precision digital filter is used. In this case, set the crossover frequency to something other than **Bypass**.
- Upon purchase, the crossover frequency is set to **Bypass**.

## ❖ Adjusting the distance of the different speakers

Adjust the distance between you and the different speakers. This setting is only valid for the **AUDIO OUT** terminals.

### ⚠ Caution

- This cannot be selected when **Audio Output Mode** is set to **2 Channel**. Change the setting to **Multi-channel** (page 43).
- Speaker Distance** of the speakers set to **None** or **No** at **Speaker Setup** cannot be adjusted (above).

#### 1 Select and set Speakers → Speaker Distance → Next Screen.

Use **↑/↓** to select, then press **ENTER**.

#### 2 Select the speaker and adjust the distance.

Use **↑/↓** to select, then use **←/→** to adjust.

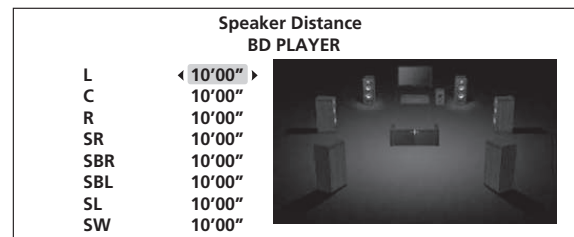

- The distance of all the speakers can be set to between 1 inch and 45 feet, in units of 1 inch.

## ❖ Adjusting the output level of the different speakers (Channel Level)

Adjust each output level of the different speakers by using test tones. This setting is only valid for the **AUDIO OUT** terminals.

### ⚠ Caution

- This cannot be selected when **Audio Output Mode** is set to **2 Channel**. Change the setting to **Multi-channel** (page 43).
- Channel Level** of the speakers set to **None** or **No** at **Speaker Setup** cannot be adjusted (above).
- Test tones are output. Lower the volume of the device connected to the player.

#### 1 Select and set Speakers → Channel Level, then Fix or Variable.

Use **↑/↓** to select, then press **ENTER**.

- Fix** – The output level of all the speakers is set to the maximum.
- Variable** – The output level of all the speakers is set 6.0 dB lower than when **Fix** is selected. From this point, the output levels of the **L, C, R, SL, SR, SBL, SBR** and **SW** speakers can be adjusted within the range of **-6.0 dB to +6.0 dB**.

If you have selected **Variable**, proceed to step 2.

## 2 Select and set the method for switching the speaker to be adjusted.

Use  $\leftarrow/\rightarrow$  to select, then press **ENTER**.

- **Auto** – Switch the speaker to be adjusted automatically.
- **Manual** – Switch the speaker to be adjusted manually.

## 3 Adjust the output level.

Use  $\uparrow/\downarrow$  to select,  $\leftarrow/\rightarrow$  to adjust.

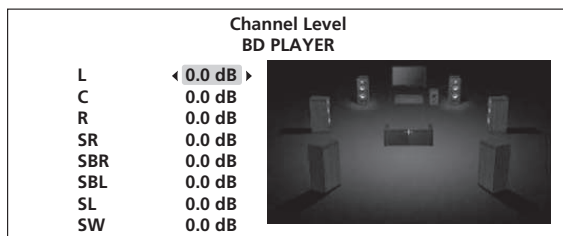

### Note

- You can also adjust while listening to the sound being played (page 40).
- The volume of the test tones output from the subwoofer may seem lower than the tones output from the other channels. Adjust the subwoofer based on the sound during playback (page 40).
- When **Auto** is selected, the speaker cannot be selected with  $\uparrow/\downarrow$ . In this case, test tones are not output from the subwoofer.

## ❖ Setting the IP address

### 1 Select and set Network → IP Address → Next Screen.

Use  $\uparrow/\downarrow$  to select, then press **ENTER**.

### 2 Set IP address.

Use  $\uparrow/\downarrow/\leftarrow/\rightarrow$  to set the IP address of the player or DNS server, then press **ENTER**.

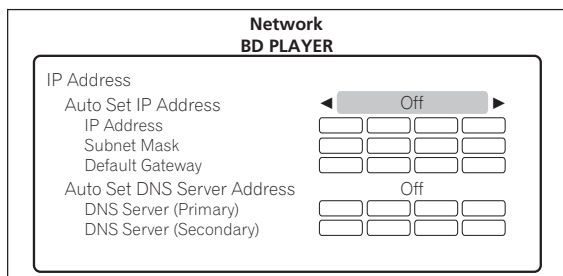

#### • Auto Set IP Address

**On** – The player's IP address is obtained automatically. Select this when using a broadband router or broadband modem that has a DHCP (Dynamic Host Configuration Protocol) server function. This player's IP address will automatically be allocated from the DHCP server.

**Off** – The player's IP address must be set manually. Use the number buttons (0 to 9) to input the IP address, subnet mask and default gateway.

#### • Auto Set DNS Server Address

**On** – The DNS server's IP address is obtained automatically.

**Off** – The DNS server's IP address must be set manually. Use the number buttons (0 to 9) to input the DNS server's IP address stipulated by your Internet service provider.

### Note

- When **Auto Set IP Address** is set to **Off**, **Auto Set DNS Server Address** is also set to **Off**.
- For information on DHCP server function, refer to the network device's operating instructions.
- You may need to contact your Internet service provider or network administrator when inputting the IP address manually.

## ❖ Setting the proxy server

Only set the proxy server if so instructed by your Internet service provider.

### 1 Select and set Network → Proxy Server → Next Screen.

Use  $\uparrow/\downarrow$  to select, then press **ENTER**.

### 2 Select and set Use or Not use at Proxy Server.

Use  $\leftarrow/\rightarrow$  to change, then press  $\downarrow$ .

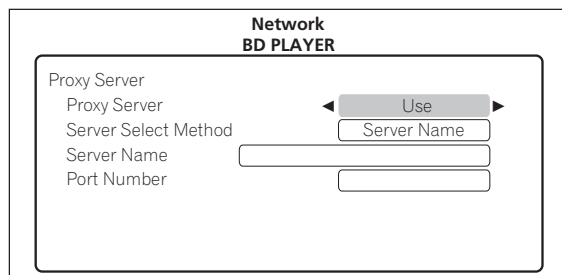

- **Use** – Select this when using a proxy server.
- **Not use** – Select this when not using a proxy server.

If you have selected **Use**, proceed to step 3.

### 3 Select and set Server Select Method.

Use  $\leftarrow/\rightarrow$  to change, then press  $\downarrow$ .

- **IP Address** – Input the IP address.
- **Server Name** – Input the server name.

### 4 Input IP Address or Server Name.

Use the number buttons (0 to 9) to input the number if you select IP address by step 3. Use  $\leftarrow/\rightarrow$  to move the cursor. Use the number buttons (0 to 9) to input characters if you select Server Name by step 3.

The characters that can be input for the server name are listed on the table below. Pressing a button repeatedly cycles through the characters shown.



- If you want to enter two characters in succession that are both on the same button (for example a **P** and an **R**), press **→** after inputting the first character then input the second character.
- Use **CLEAR** to delete the last character.
- Use **←/→** to move the displayed characters when all the input characters cannot be displayed.

Key	Characters	Key	Characters
1	1 . -	6	m n o 6
2	a b c 2	7	p q r s 7
3	d e f 3	8	t u v 8
4	g h i 4	9	w x y z 9
5	j k l 5	0	0

#### 5 Input Port Number.

Press **↓**, use the number buttons (0 to 9) to input the number.

#### 6 Press **ENTER** to set.

### ❖ Displaying the network settings

▶ **Select and set Network → Display Network Configuration → Next Screen.**

Use **↑/↓** to select, then press **ENTER**.

The MAC address, IP address, subnet mask, default gateway and DNS server (primary and secondary) settings are displayed.

When **Auto Set IP Address** is set to **On**, the values obtained automatically are displayed.

#### **Note**

- "0.0.0.0" is displayed when each IP address has not been set.

### ❖ Testing the network connection

▶ **Select and set Network → Connection Test → Start.**

Use **↑/↓** to select, then press **ENTER**.

"Network connection test completed successfully." is displayed once the test is completed. If any other message is displayed, check the connections and/or settings (pages 22 and 48).

### ❖ Changing to other language at language setting

#### 1 Select and set Language.

Use **↑/↓** to select, then press **ENTER**.

#### 2 Select and set Audio Language, Subtitle Language or BDMV/DVD-Video Menu Lang.

Use **↑/↓** to select, then press **ENTER**.

#### 3 Select and set Other.

Use **↑/↓** to select, then press **ENTER**.

#### 4 Change the language.

Use **←/→** to change, then press **ENTER**.

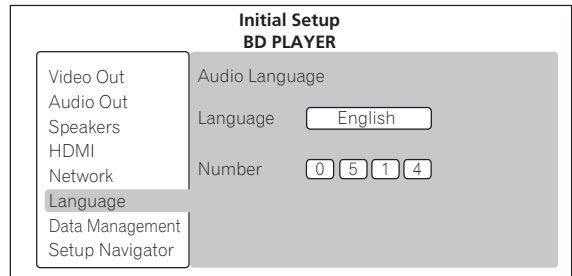

- The language can also be changed using the number buttons. Use **↑/↓** to move the cursor to **Number**, use the number buttons (0 to 9) to input the number, then press **ENTER**. Refer to *Language Code Table and Country/Area Code Table* on page 54.

#### **Note**

- If a language not recorded on the BD/DVD is set, one of the recorded languages is automatically selected and played.

### ❖ Erasing data that has been added to BDs and application data

Use this procedure to erase data that has been added to BDs (data downloaded with the BD-LIVE function and data used with the BONUSVIEW function) and application data.

#### **Caution**

- Some time is required to erase the data.
- Do not unplug the power cord while data is being erased.
- This operation does not work when a disc is loaded.

#### 1 Select and set Data Management.

Use **↑/↓** to select, then press **ENTER**.

#### 2 Select and set the erase menu.

Use **↑/↓** to select, then press **ENTER**.

##### • Individual/Shared Data Erase

Use this procedure to select and erase data downloaded with the BD-LIVE function and data used with the BONUSVIEW function (page 9).

Select **Next Screen**, then press **ENTER**. The list screen appears.

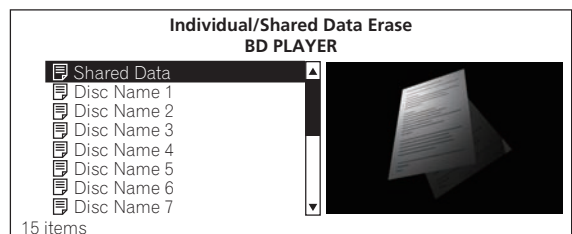

When a disc name is selected, the data downloaded with the BD-LIVE function and data used with the BONUSVIEW is erased.

When **Shared Data** is selected, all the data downloaded with the BD-LIVE function and not associated to discs is erased.

Use **↑/↓** to select the data to be erased, then press **ENTER**.

#### • Application Data Erase

Use this procedure to erase BD-ROM application data (high scores of games, bookmarks data, etc.).

Select **Start**, then press **ENTER**.

#### • Storage Format

Use this procedure to format the storage in which the data downloaded with the BD-LIVE function and data used with the BONUSVIEW function is stored (page 9).

**When this is done, all the data on the external storage device is erased.**

Select **Start**, then press **ENTER**.

### 3 Select Yes, then press ENTER.

Use **←/→** to select, then press **ENTER**.

### ❖ Registering or Changing the password

Use this procedure to register or change the code number required for the Parental Lock settings.

#### 1 Select and set Parental Lock → Set Password → Next Screen.

Use **↑/↓** to select, then press **ENTER**.

#### 2 Input the password.

Use the number buttons (0 to 9) or **↑/↓** to input the number, then press **ENTER** to set.

Use **←/→** to move the cursor.

#### 3 Re-input the password.

Use the number buttons (0 to 9) or **↑/↓** to input the number, then press **ENTER** to set.

Use **←/→** to move the cursor.

- To change the password, input the previously registered password, then input the new password.

#### Note

- We recommend making a note of the password.
- If you forget the password, reset the player to the factory default setting, then register the password again (page 51).

### ❖ Changing the Parental Lock level for viewing DVDs

Some DVD-Video discs containing scenes of violence, for example, have Parental Lock levels (check the indications on the disc's jacket or elsewhere). To restrict viewing these discs, set the player's level to the level lower than the discs.

#### 1 Select and set Parental Lock → DVD-Video Parental Lock → Next Screen.

Use **↑/↓** to select, then press **ENTER**.

#### 2 Input the password.

Use the number buttons (0 to 9) or **↑/↓** to input the number, then press **ENTER** to set.

Use **←/→** to move the cursor.

#### 3 Change the level.

Use **←/→** to change, then press **ENTER** to set.

#### Note

- The level can be set to **Off** or between **Level1** and **Level8**. When set to **Off**, viewing is not restricted.

### ❖ Changing the Age Restriction for viewing BD-ROMs

For BD-ROMs containing scenes of violence, for example, viewing can be restricted by setting an age restriction for the BD-ROMs.

#### 1 Select and set Parental Lock → BDMV Parental Lock → Next Screen.

Use **↑/↓** to select, then press **ENTER**.

#### 2 Input the password.

Use the number buttons (0 to 9) or **↑/↓** to input the number, then press **ENTER** to set.

Use **←/→** to move the cursor.

#### 3 Change the age.

Use the number buttons (0 to 9) or **↑/↓** to input the number, then press **ENTER** to set.

Use **←/→** to move the cursor.

#### Note

- When **Age Restriction** is set to **255**, viewing is not restricted.

### ❖ Changing the Country/Area code

#### 1 Select and set Parental Lock → Country Code → Next Screen.

Use **↑/↓** to select, then press **ENTER**.

#### 2 Input the password.

Use the number buttons (0 to 9) or **↑/↓** to input the number, then press **ENTER** to set.

Use **←/→** to move the cursor.

#### 3 Change the country/area code.

Use **←/→** to change, then press **ENTER** to set.

- The the country/area code can also be changed using the number buttons. Use **↑/↓** to move the cursor to **Number**, use the number buttons (0 to 9) to input the number, then press **ENTER**. Refer to *Language Code Table and Country/Area Code Table* on page 54.

## ❖ Setting the output terminals

Set the terminals from which the player's video and audio signals are to be output.

### 1 Select and set Options → Output Terminal → Next Screen.

Use **↑/↓** to select, then press **ENTER**.

### 2 Select and set the video and audio output terminals.

Select the actually connected video and audio output terminals.

Use **↑/↓/←/→** to select, then press **ENTER**.

For details on the settings, refer to step 4 on page 23.

When **COMPONENT VIDEO** or **VIDEO** is selected for **Video**, no sound is output from the **HDMI OUT** terminal (a warning message is displayed).

## Software updating

The software of the player can be updated by connecting it to the Internet using a LAN cable.

Before updating the software, make sure that you have connected the player to the network and made the necessary settings (pages 22 and 48).

### Caution

- 10 to 20 minutes are required to update the software. The picture turns off during this process, but do not unplug the power cord until the front panel display turns off.
- When the front panel display is off, turn it on with **FL DIMMER**. When updating the player's software with the front panel display off, do not unplug the power cord until the **FL OFF** indicator turns off.
- Depending on the Internet connection conditions, downloading may take a long time.
- Do not unplug the power cord during software updating. Doing so may result in an operation failure.
- There are two processes for software updating, downloading and updating. Both processes may take a certain period of time.
- Other operations are defeated during software updating. Furthermore updating process cannot be canceled.

### Note

- Steps **1** to **4** are the operations performed by the user (they are intended to download the software from the Internet).
- Steps **5** to **7** are the operations performed (automatically) by the player (they are intended to update the software).

### 1 When playback is stopped, display the Home Menu screen.

Press  **HOME MENU**.

### 2 Select and set Initial Setup.

Use **↑/↓** to select, then press **ENTER**.

### 3 Select and set Options → Software Update → Start.

Use **↑/↓** to select, then press **ENTER**.

- If the player is already running the latest software, the message "The player's software is up to date and does not need updating." is displayed.

### 4 Select and set Yes.

Use **←/→** to select **Yes**, then press **ENTER**.

- The help menu is displayed if the player cannot connect to the Internet. Check the connections and settings (pages 22 and 48).

### 5 Downloading of the software start.

The software download status is displayed on the screen.

- Depending on the Internet connection conditions, software downloading may take a certain period of time.

### 6 Updating starts.

"**DOWNLOAD**" and a number are displayed on the front panel display, after which the display switches alternately between this and "**DATA CHECK**", "**WRT IPL**", "**WRT SD**", "**WRT KRNL**", "**WRT SYS1**", "**WRT SYS2**", "**WRT DRV**" and "**WRT FLC**".

- Software updating may take a certain period of time.

### 7 Updating completes.

The front panel display shows "**DOWNLOAD OK**" and the player turns off automatically.

## Restoring all the settings to the factory default settings

### 1 Check that the player's power is turned on.

### 2 Check that there is no disc in the player.

If there is a disc in the player, remove it.

### 3 While pressing , press **STANDBY/ON**.

Operate using the buttons on the player's front panel.

### Note

- After restoring all the settings to the factory default settings, use **Setup Navigator** to reset the player (page 23).
- When all the settings are restored to the factory defaults, all the data for the secondary video (Picture-in-Picture), secondary audio, bookmarks, etc., is erased.
- If a disc is loaded, the settings cannot be restored to the factory defaults by performing the above operation.

# 07 About the audio output settings

The audio signals that are output differ according to the audio format recorded on the disc and the player's settings. Check on the table below.

## ⚠ Caution

- When **ANALOG AUDIO** is selected at **Output Terminal**, no audio signals are output from the **HDMI OUT** terminal or **DIGITAL OUT** terminal (pages 23 and 51).
- When **HDMI** or **DIGITAL AUDIO** is selected at **Output Terminal**, linear PCM audio signals (2 channels) are output from all terminals other than the ones selected at **Output Terminal** (pages 23 and 51).
- The output from all terminals other than the ones selected for **Audio** does not sound as intended by the content provider.

Audio format	AUDIO OUT terminals		DIGITAL OUT terminal		HDMI OUT terminal		
	2ch <sup>1</sup>	Multi-channel <sup>1</sup>	Converted to linear PCM audio <sup>2</sup>	Not converted to linear PCM audio <sup>3</sup>	PCM <sup>4</sup>	Auto <sup>4</sup>	
BD-ROM	Dolby Digital	5.1-channel audio			5.1-channel audio	Dolby Digital <sup>6,7</sup>	
	Dolby Digital Plus			Dolby Digital <sup>5</sup>	7.1-channel audio	Dolby Digital Plus <sup>6,7</sup>	
	Dolby TrueHD				7.1-channel audio <sup>8</sup>	Dolby TrueHD <sup>6,7,9</sup>	
	DTS Digital Surround	Converted to 2-channel audio	7.1-channel audio	Converted to 2-channel audio		7.1-channel audio	DTS Digital Surround <sup>6,10</sup>
	DTS-HD High Resolution Audio			DTS Digital Surround <sup>5</sup>	7.1-channel audio <sup>8</sup>	DTS-HD High Resolution Audio <sup>6,8,10</sup>	
	DTS-HD Master Audio		7.1-channel audio			DTS-HD Master Audio <sup>6,10,11</sup>	
	Linear PCM				Converted to 2-channel audio	7.1-channel audio <sup>8</sup>	
BD-R/-RE	Dolby Digital	Converted to 2-channel audio	5.1-channel audio	Converted to 2-channel audio	Dolby Digital	5.1-channel audio	Dolby Digital <sup>7</sup>
	MPEG-2 AAC				MPEG-2 AAC		MPEG-2 AAC
	MPEG			2-channel audio			
	Linear PCM						
DVD-Video	Dolby Digital	Converted to 2-channel audio	5.1-channel audio	Converted to 2-channel audio	Dolby Digital	5.1-channel audio	Dolby Digital <sup>7</sup>
	DTS Digital Surround				DTS Digital Surround		DTS Digital Surround <sup>10</sup>
	MPEG			2-channel audio			
	Linear PCM						
DVD-R/-RW (VR format)	Dolby Digital	Converted to 2-channel audio	5.1-channel audio	Converted to 2-channel audio	Dolby Digital	5.1-channel audio	Dolby Digital <sup>7</sup>
	MPEG			2-channel audio			
	Linear PCM						

- When **Audio Output Mode** is set to **2 Channel** or **Multi-channel** (page 43).
- When **Dolby Digital Out** is set to **Dolby Digital → PCM**, **DTS Out** is set to **DTS → PCM**, or **AAC Out** is set to **AAC → PCM** (page 43).
- When **Dolby Digital Out** is set to **Dolby Digital 1/Dolby Digital 2**, **DTS Out** is set to **DTS 1/DTS 2** or **AAC Out** is set to **AAC** (page 43).
- When **HDMI Audio Out** is set to **PCM** or **Auto** (page 44).
- When outputting Dolby Digital or DTS Digital Surround bitstream with **Dolby Digital Out** set to **Dolby Digital 2** and **DTS Out** set to **DTS 2**, the secondary audio and interactive audio signals are not mixed for output.
- When outputting the bitstream of Dolby TrueHD, Dolby Digital Plus, Dolby Digital, DTS Digital, DTS-HD Master Audio, DTS-HD High Resolution Audio or DTS Digital Surround, the secondary audio and interactive audio signals are not mixed for output.
- If the connected HDMI device is not compatible with Dolby TrueHD or Dolby Digital Plus bitstream, the signals are output in linear PCM (7.1 channels) or Dolby Digital bitstream.  
If the connected HDMI device is not compatible with Dolby Digital bitstream, the signals are output in linear PCM (2 channels).
- When the output video resolution is set to 480i/576i or 480p/576p, the signals may be output in linear PCM (2 channels), depending on **HDMI High Speed Transmission** setting and/or the connected HDMI device (page 18).

9. When the output video resolution is set to 480i/576i or 480p/576p, the signals may be output in linear PCM (2 channels) or Dolby Digital bitstream, depending on **HDMI High Speed Transmission** setting and/or the connected HDMI device (page 18).
10. If the connected HDMI device is not compatible with DTS-HD Master Audio or DTS-HD High Resolution Audio, the signals are output in linear PCM (7.1 channels) or DTS Digital Surround bitstream.  
If the connected HDMI device is not compatible with DTS Digital Surround bitstream, the signals are output in linear PCM (2 channels).
11. When the output video resolution is set to 480i/576i or 480p/576p, the signals may be output in linear PCM (2 channels) or DTS Digital Surround, depending on **HDMI High Speed Transmission** setting and/or the connected HDMI device.

**Note**

- Only compatible with 7.1-channel surround back. 6.1-channel surround back is output in 7.1 channels. In other cases, output as audio signals of 5.1-channels or less.
- When outputting linear PCM audio signals, if the number of compatible channels of the connected HDMI device is lower, the signals are output with the number of channels for which the device is compatible.
- The audio signals output from the **DIGITAL OUT** terminal have a sampling frequency of 48 kHz (44.1 kHz for audio CDs).

# Language Code Table and Country/Area Code Table

## ❖ Language Code Table

Language name, language code, input code

Abkhazian, <b>ab/abk</b> , 0102	French, <b>fr/fra</b> , 0618	Malagasy, <b>mg/mlg</b> , 1307	Slovenian, <b>sl/slv</b> , 1912
Afar, <b>aa/aar</b> , 0101	Galician, <b>gl/glg</b> , 0712	Malay, <b>ms/msa</b> , 1319	Somali, <b>so/som</b> , 1915
Afrikaans, <b>af/afz</b> , 0106	Georgian, <b>ka/kat</b> , 1101	Malayalam, <b>ml/mal</b> , 1312	Sotho, Southern, <b>st/sot</b> , 1920
Albanian, <b>sq/sqi</b> , 1917	German, <b>de/deu</b> , 0405	Maltese, <b>mt/mlt</b> , 1320	Spanish, <b>es/spa</b> , 0519
Amharic, <b>am/amh</b> , 0113	Greek, <b>el/ell</b> , 0512	Maori, <b>mi/mri</b> , 1309	Sundanese, <b>su/sun</b> , 1921
Arabic, <b>ar/ara</b> , 0118	Guarani, <b>gn/grn</b> , 0714	Marathi, <b>mr/mar</b> , 1318	Swahili, <b>sw/swa</b> , 1923
Armenian, <b>hy/hye</b> , 0825	Gujarati, <b>gu/guj</b> , 0721	Mongolian, <b>mn/mon</b> , 1314	Swati, <b>ss/ssw</b> , 1919
Assamese, <b>as/asm</b> , 0119	Hausa, <b>ha/hau</b> , 0801	Moldavian, <b>mo/mol</b> , 1315	Swedish, <b>sv/swe</b> , 1922
Aymara, <b>ay/aym</b> , 0125	Hebrew, <b>iw/heb</b> , 0923	Nauru, <b>na/nau</b> , 1401	Tagalog, <b>tl/tgl</b> , 2012
Azerbaijani, <b>az/aze</b> , 0126	Hindi, <b>hi/hin</b> , 0809	Nepali, <b>ne/nep</b> , 1405	Tajik, <b>tg/tgk</b> , 2007
Bashkir, <b>ba/bak</b> , 0201	Hungarian, <b>hu/hun</b> , 0821	Norwegian, <b>no/nor</b> , 1415	Tamil, <b>ta/tam</b> , 2001
Basque, <b>eu/eus</b> , 0521	Icelandic, <b>is/isl</b> , 0919	Occitan, <b>oc/oci</b> , 1503	Tatar, <b>tt/tat</b> , 2020
Belarusian, <b>be/bel</b> , 0205	Indonesian, <b>in/ind</b> , 0914	Oriya, <b>or/ori</b> , 1518	Telugu, <b>te/tel</b> , 2005
Bengali, <b>bn/ben</b> , 0214	Interlingua, <b>ia/ina</b> , 0901	Oromo, <b>om/orm</b> , 1513	Thai, <b>th/tha</b> , 2008
Bihari, <b>bh/bih</b> , 0208	Interlingue, <b>ie/ile</b> , 0905	Panjabi, <b>pa/pan</b> , 1601	Tibetan, <b>bo/bod</b> , 0215
Bislama, <b>bi/bis</b> , 0209	Inupiaq, <b>ik/ikp</b> , 0911	Persian, <b>fa/fas</b> , 0601	Tigrinya, <b>ti/tir</b> , 2009
Breton, <b>br/bre</b> , 0218	Irish, <b>ga/gle</b> , 0701	Polish, <b>pl/pol</b> , 1612	Tonga (Tonga Islands), <b>to/ton</b> , 2015
Bulgarian, <b>bg/bul</b> , 0207	Italian, <b>it/ita</b> , 0920	Portuguese, <b>pt/por</b> , 1620	Tsonga, <b>ts/tso</b> , 2019
Burmese, <b>my/mya</b> , 1325	Japanese, <b>ja/jpn</b> , 1001	Pushto, <b>ps/pus</b> , 1619	Tswana, <b>tn/tsn</b> , 2014
Catalan, <b>ca/cat</b> , 0301	Javanese, <b>iw/jav</b> , 1023	Quechua, <b>qu/que</b> , 1721	Turkmen, <b>tk/tuk</b> , 2011
Central Khmer, <b>km/khm</b> , 1113	Kalaallisut, <b>kl/kal</b> , 1112	Romanian, <b>ro/ron</b> , 1815	Turkish, <b>tr/tur</b> , 2018
Chinese, <b>zh/zho</b> , 2608	Kannada, <b>kn/kan</b> , 1114	Romansch, <b>rm/roh</b> , 1813	Twi, <b>tw/twi</b> , 2023
Corsican, <b>co/cos</b> , 0315	Kashmiri, <b>ks/kas</b> , 1119	Rundi, <b>rn/run</b> , 1814	Ukrainian, <b>uk/ukr</b> , 2111
Croatian, <b>hr/hrv</b> , 0818	Kazakh, <b>kk/kaz</b> , 1111	Russian, <b>ru/rus</b> , 1821	Urdu, <b>ur/urd</b> , 2118
Czech, <b>cs/ces</b> , 0319	Kinyarwanda, <b>rw/kin</b> , 1823	Samoan, <b>sm/smo</b> , 1913	Uzbek, <b>uz/uzb</b> , 2126
Danish, <b>da/dan</b> , 0401	Kirghiz, <b>ky/kir</b> , 1125	Sango, <b>sg/sag</b> , 1907	Vietnamese, <b>vi/vie</b> , 2209
Dutch, <b>nl/nld</b> , 1412	Korean, <b>ko/kor</b> , 1115	Sanskrit, <b>sa/san</b> , 1901	Volapük, <b>vo/vol</b> , 2215
Dzongkha, <b>dz/dzo</b> , 0426	Kurdish, <b>ku/kur</b> , 1121	Scottish Gaelic, <b>gd/gla</b> , 0704	Welsh, <b>cy/cym</b> , 0325
English, <b>en/eng</b> , 0514	Lao, <b>lo/lao</b> , 1215	Serbian, <b>sr/srp</b> , 1918	Western Frisian, <b>fy/fry</b> , 0625
Esperanto, <b>eo/epo</b> , 0515	Latin, <b>la/lat</b> , 1201	Serbo-Croatian, <b>sh/---</b> , 1908	Wolof, <b>wo/wol</b> , 2315
Estonian, <b>et/est</b> , 0520	Latvian, <b>lv/lav</b> , 1222	Shona, <b>sn/sna</b> , 1914	Xhosa, <b>xh/xho</b> , 2408
Finnish, <b>fi/fin</b> , 0609	Lingala, <b>ln/lin</b> , 1214	Sindhi, <b>sd/snd</b> , 1904	Yiddish, <b>ji/yid</b> , 1009
Fijian, <b>fj/fij</b> , 0610	Lithuanian, <b>lt/lit</b> , 1220	Sinhalese, <b>si/sin</b> , 1909	Yoruba, <b>yo/yor</b> , 2515
Faroese, <b>fo/fao</b> , 0615	Macedonian, <b>mk/mkd</b> , 1311	Slovak, <b>sk/slk</b> , 1911	Zulu, <b>zu/zul</b> , 2621

## ❖ Country/Area Code Table

Country/Area name, Country/Area code, input code

Anguilla, <b>ai</b> , 0109	Estonia, <b>ee</b> , 0505	Luxembourg, <b>lu</b> , 1221	Slovakia, <b>sk</b> , 1911
Antigua and Barbuda, <b>ag</b> , 0107	Finland, <b>fi</b> , 0609	Macedonia, the Former Yugoslav Republic of, <b>mk</b> , 1311	Slovenia, <b>si</b> , 1909
Argentina, <b>ar</b> , 0118	France, <b>fr</b> , 0618	Malaysia, <b>my</b> , 1325	Spain, <b>es</b> , 0519
Armenia, <b>am</b> , 0113	Georgia, <b>ge</b> , 0705	Malta, <b>mt</b> , 1320	Suriname, <b>sr</b> , 1918
Australia, <b>au</b> , 0121	Germany, <b>de</b> , 0405	Mexico, <b>mx</b> , 1324	Sweden, <b>se</b> , 1905
Austria, <b>at</b> , 0120	Greece, <b>gr</b> , 0718	Moldova, Republic of, <b>md</b> , 1304	Switzerland, <b>ch</b> , 0308
Azerbaijan, <b>az</b> , 0126	Greenland, <b>gl</b> , 0712	Monaco, <b>mc</b> , 1303	Taiwan, Province of China, <b>tw</b> , 2023
Bahamas, <b>bs</b> , 0219	Grenada, <b>gd</b> , 0704	Montserrat, <b>ms</b> , 1319	Tajikistan, <b>tj</b> , 2010
Barbados, <b>bb</b> , 0202	Guyana, <b>gy</b> , 0725	Netherlands, <b>nl</b> , 1412	Thailand, <b>th</b> , 2008
Belarus, <b>by</b> , 0225	Haiti, <b>ht</b> , 0820	New Zealand, <b>nz</b> , 1426	Trinidad and Tobago, <b>tt</b> , 2020
Belgium, <b>be</b> , 0205	Hong Kong, <b>hk</b> , 0811	Norway, <b>no</b> , 1415	Tunisia, <b>tn</b> , 2014
Belize, <b>bz</b> , 0226	Hungary, <b>hu</b> , 0821	Pakistan, <b>pk</b> , 1611	Turkey, <b>tr</b> , 2018
Bermuda, <b>bm</b> , 0213	Iceland, <b>is</b> , 0919	Philippines, <b>ph</b> , 1608	Turkmenistan, <b>tm</b> , 2013
Brazil, <b>br</b> , 0218	India, <b>in</b> , 0914	Poland, <b>pl</b> , 1612	Turks and Caicos Islands, <b>tc</b> , 2003
Bulgaria, <b>bg</b> , 0207	Indonesia, <b>id</b> , 0904	Portugal, <b>pt</b> , 1620	Ukraine, <b>ua</b> , 2101
Canada, <b>ca</b> , 0301	Ireland, <b>ie</b> , 0905	Puerto Rico, <b>pr</b> , 1618	United Kingdom, <b>gb</b> , 0702
Cayman Islands, <b>ky</b> , 1125	Israel, <b>il</b> , 0912	Romania, <b>ro</b> , 1815	United States, <b>us</b> , 2119
Chile, <b>cl</b> , 0312	Italy, <b>it</b> , 0920	Russian Federation, <b>ru</b> , 1821	Uruguay, <b>uy</b> , 2125
China, <b>cn</b> , 0314	Jamaica, <b>jm</b> , 1013	Saint Kitts and Nevis, <b>kn</b> , 1114	Uzbekistan, <b>uz</b> , 2126
Colombia, <b>co</b> , 0315	Japan, <b>jp</b> , 1016	Saint Lucia, <b>lc</b> , 1203	Venezuela, <b>ve</b> , 2205
Croatia, <b>hr</b> , 0818	Kazakhstan, <b>kz</b> , 1126	Saint Vincent and the Grenadines, <b>vc</b> , 2203	Virgin Islands, British, <b>vg</b> , 2207
Cyprus, <b>cy</b> , 0325	Korea, Republic of, <b>kr</b> , 1118	San Marino, <b>sm</b> , 1913	
Czech Republic, <b>cz</b> , 0326	Kyrgyzstan, <b>kg</b> , 1107	Singapore, <b>sg</b> , 1907	
Denmark, <b>dk</b> , 0411	Latvia, <b>lv</b> , 1222		
Dominica, <b>dm</b> , 0413	Liechtenstein, <b>li</b> , 1209		
Dominican Republic, <b>do</b> , 0415	Lithuania, <b>lt</b> , 1220		

# Chapter 8 Advanced setup

## Changing the settings

## Operating the Advanced Setup screen

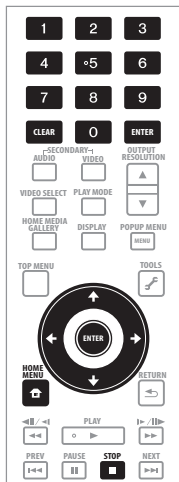

1 When playback is stopped, display the Home Menu screen.

Press **HOME MENU**.

2 Select and set Initial Setup → Advanced Setup.

Use **↑/↓** to select, then press **ENTER**.

3 Select the item and change the setting.

Use **↑/↓/←/→** to select, then press **ENTER**.

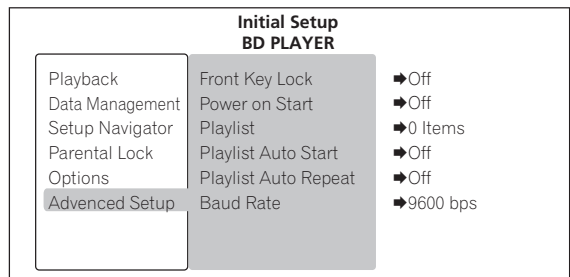

### ❖ Closing the Advanced Setup screen

Press **HOME MENU**.

### Note

- Items that cannot be changed are indicated in gray. The items that can be selected depend on the player's status.
- In Options, the factory default settings are indicated in bold.

Setting	Options	Explanation
Advanced Setup Front Key Lock	ALL	Select this to lock operation of the buttons on the player's front panel and opening/closing of the disc tray.
	Tray	Select this to only lock opening/closing of the disc tray.
	<b>Off</b>	Select this if you do not want to lock operation of the buttons on the player's front panel and opening/closing of the disc tray.
Power on Start	On	Select this if you want the power to turn on automatically when the power cord is plugged into a power outlet.
	<b>Off</b>	Select this if you do not want the power to turn on automatically when the power cord is plugged into a power outlet.
Playlist		Creates a playlist (page 56).
Playlist Auto Start	On	Select this if you want the play the playlist automatically when the power is turned on or <b>▶</b> is pressed.
	<b>Off</b>	Select this if you do not want to play the playlist automatically when the power is turned on or <b>▶</b> is pressed.

Setting	Options	Explanation
Advanced Setup Playlist Auto Repeat	On	Select this if you want to play the playlist repeatedly.
	<b>Off</b>	Select this if you do not want to play the playlist repeatedly.
Baud Rate	2400 bps	Set the RS-232C terminal's signal transfer speed to 2 400 bps.
	4800 bps	Set the RS-232C terminal's signal transfer speed to 4 800 bps.
	<b>9600 bps</b>	Set the RS-232C terminal's signal transfer speed to 9 600 bps.
	19200 bps	Set the RS-232C terminal's signal transfer speed to 19 200 bps.
	115200 bps	Set the RS-232C terminal's signal transfer speed to 115 200 bps.

## Playing titles/chapters in the registered order (Playlist)

Register titles/chapters on the playlist and play them in the order in which they were registered.

The discs that can be played with a playlist are as follows:

- DVDs recorded in **DVD-Video format**
- BDs recorded in **BDMV format**

### ⚠ Caution

- To create and play the playlist, use discs created specifically for this player, not commercially available discs. When a commercially available disc is used, the player may not play in the order registered on the playlist due to the program on the disc.

## Creating playlist

Register titles/chapters and create the playlist.

### 1 When playback is stopped, display the Home Menu screen.

Press **HOME MENU**.

### 2 Select and set Initial Setup.

Use **↑/↓** to select, then press **ENTER**.

### 3 Select and set Advanced Setup → Playlist → Next Screen.

Use **↑/↓** to select, then press **ENTER**.

### 4 Select "--- - ---".

Use **↑/↓** to select, then press **ENTER**.

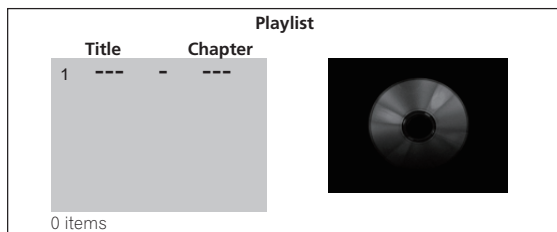

### 5 Input the title/chapter you want to register.

Use the number buttons (0 to 9) or **↑/↓** to input the number.

Use **←/→** to move the cursor.

- To register title 32, chapter 3, input **0, 3, 2, 0, 0** and **3**.

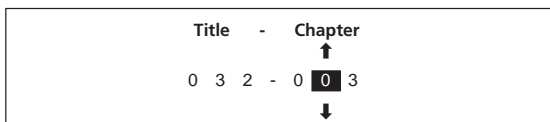

### 6 Register the title/chapter.

Press **ENTER**. The specified title/chapter is registered on the playlist. To register more titles/chapters, repeat steps 4 to 6.

### 7 Close the Playlist screen.

Press **HOME MENU**.

### ✍ Note

- Title numbers and chapter numbers can be changed by selecting already registered titles/chapters.
- **000** cannot be registered for the title number.
- When **000** is entered for the chapter number, all the chapters of the registered title are registered.
- A maximum of 24 titles/chapters can be registered on the playlist.
- All titles/chapters registered on the playlist are deleted when all the player's settings are restored to the factory defaults (page 51).
- Depending on the disc and contents, titles/chapters may not be playable, even when registered on the playlist.

### ❖ Deleting titles/chapters from the playlist

Use **↑/↓** to select the title/chapter to be deleted, then press **CLEAR**.

### ❖ Deleting all titles/chapters from the playlist

First press **TOOLS**, next use **↑/↓** to select **Delete all playlists**, then press **ENTER**. Use **←/→** to select **Yes**, then press **ENTER**.



## Playing the playlist



### Caution

- Depending on the disc or operation, the titles/chapters may not be played as they were registered on the playlist.
- The playlist cannot be played from the playlist screen. Perform the operation below to play the playlist.



#### 1 When playback is stopped, display the Home Menu screen.

Press  HOME MENU.

#### 2 Select and set Initial Setup.

Use / to select, then press ENTER.

#### 3 Select and set Advanced Setup → Playlist Auto Start → On.



Use / to select, then press ENTER.

#### 4 Close the Initial Setup screen.

Press  HOME MENU.

#### 5 Play the playlist.

Press  PLAY.

Playback continues through to the end of the last title/chapter registered on the playlist. When the /  is pressed during playback, playback skips from the currently playing title/chapter to the previous/next title/chapter registered in the playlist.

### Note

- The Resume playback and Play Mode functions do not work when **Playlist Auto Start** is set to **On**.
- If you do not want to play the playlist, set **Playlist Auto Start** to **Off**.

# Additional information

## Serial interface specifications

In addition to the basic operations on the player's front panel and remote control, the player is equipped with a serial interface conforming to RS-232C standards allowing connection to a computer. The interface is a 9-pin D-Sub connector.

### Caution

- The 9-pin connector uses inch screw threads.

The D-Sub connector's pin layout is as shown below.

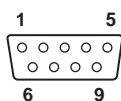

Pin no.	Terminal	Input/Output	Function
1	DCD	Input	NC (not connected on the player)
2	RxD	Input	receive data
3	TxD	Output	send data
4	DTR	Output	NC (not connected on the player)
5	GND	--	ground
6	DSR	Input	NC (not connected on the player)
7	RTS	Output	Connected to CTS pin internally.
8	CTS	Input	Connected to RTS pin internally.
9	RI	Input	NC (not connected on the player)

## Serial control specifications

### (1) Signal level

RS-232C level

### (2) Data format

Data length: 8 bits

Stop bit: 1 bit

Parity: None

### (3) Communication speed (Baud rate)

The communication speed (Baud rate) is selectable among the following: **2400 bps**, **4800 bps**, **9600 bps**, **19200 bps** and **115200 bps**. Set to **9600 bps** by factory default (page 56).

## Connection to a computer

The player communicates with the computer using the 9-pin D-Sub connector's pins 2 and 3 for signal transfer and pin 5 as the ground.

The computer and player are connected as shown on the diagram below.

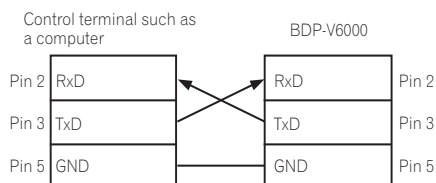

The player can accept commands whenever the power is on. In addition, the player can accept the commands below even when the power is off.

- Power ON command
- Play command
- Commands with the power (A181AFBC), play (A181AF39) and power on (A181AFBA) Remote Control Button commands as arguments.

There is no need to connect control lines other than **TxD** and **RxD**.

# Commands and statuses

Serial interface control is performed by the computer sending commands, etc., and the player returning the status. When command execution is fully completed, the player returns a completion message (R<CR>). If an error is generated, the player returns the error code (for example, E04<CR>).

## List of usable commands

No	Arguments	mnemonics	Command name	BD	DVD	CD
1		PN	Power ON	✓	✓	✓
2		PF	Power OFF	✓	✓	✓
3		OP	Open	✓	✓	✓
4		CO	Close	✓	✓	✓
5	99	RJ	Stop	✓	✓	✓
6	Adress	PL	Play	✓*1	✓*1	✓*1
7		PA	Pause	✓	✓	✓
8		ST	Still	✓	✓	✓
9		SF	Step Forward	✓	✓	✗
10		SR	Step Reverse	✓	✓	✗
11		NS	Scan Stop	✓	✓	✓
12	Adress	SE	Search	✓*2	✓*2	✓*2
13	Adress	SL	Search & Play	✓*2	✓*2	✓*2
14	Adress	SM	Stop Marker	✓*3	✓*3	✓*3
15		CL	Clear	✓	✓	✓
16		TM	Time	✓*4	✓*4	✓*4
17		CH	Chapter	✓*4	✓*4	✗
18		TI	Title	✓*4	✓*4	✗
19		TR	Track	✗	✗	✓*4
20	Argument	KL	Key Lock	✓	✓	✓
21	Argument	BS	Advanced Playlist Playback	✓	✓	✗
22	?A		Current Address Request	✓	✓	✓
23	?R		Title/Track Number Request	✓	✓	✓
24	?C		Chapter Number Request	✓	✓	✗
25	?T		Time Code Request	✓	✓	✓
26	?I		Index Number Request	✗	✗	✓
27	?V		DVD Disc Status Request	✗	✓	✗
28	?J		BD Disc Status Request	✓	✗	✗
29	?D		Get Information	✓	✓	✓
30	?K		CD Disc Status Request	✗	✗	✓
31	?P		Player Active Mode Request	✓	✓	✓
32	?L		Player Model Name Request	✓	✓	✓

No	Arguments	mnemonics	Command name	BD	DVD	CD
33	Argument	SW	Slow	✓	✓	✗
34		?E	Error Code Request	✓	✓	✓
35	Argument	MC	Menu Call	✓	✓	✗
36	Argument	NB	Numeric Button	✓	✓	✗
37	Argument	CU	Button Select	✓	✓	✗
38		ET	Enter Button	✓	✓	✗
39		?Z	Firmware Version Request	✓	✓	✓
40	/Argument/	RU	Remote Control Button	✓	✓	✓

\*1 The PL commands include both the PL command without address and the PL command with address. The PL command without address is set to ✓ for the respective discs, but how the PL command with address is handled differs according to the address mode.

\*2 For the SE and SP commands, handling differs according to the address mode. See Table 2 for details.

\*3 For the SM command, handling differs according to the address mode. See Table 1 for details.

\*4 Used to specify the address mode specification when using the PL, SE, SP and SM commands. Handling differs according to the command being used. See Tables 1 and 2 for details.

Table 1 Address modes in which the PL and SM commands are valid

	BD	DVD	CD
TM(Time)	✓	✓	✓
CH(Chapter)	✓	✓	✗
TI(Title)	✓	✓	✗
TR(Track)	✗	✗	✓

Table 2 Address modes in which the SE and SL commands are valid

	BD	DVD	CD
TM(Time)	✓	✓	✓
CH(Chapter)	✓	✓	✗
TI(Title)	✓	✓	✗
TR(Track)	✗	✗	✓

## Command mnemonics

Command mnemonics consist of two-digit ASCII alphabetic coded characters. Upper-case and lower-case characters can be used without distinction.

## Arguments

(1) Arguments are placed in front of the command.

If a command requiring an argument has no argument, an error is generated.

(2) Arguments are of the following types:

### 1. Address:

The address consists of ASCII digit characters for the title number, chapter number, track number and time code, according to the address mode.

The address mode is determined by the TI, CH, TR and TM commands.

If a value greater than the maximum value is attributed, the command will not work normally.

### 2. Argument:

The argument expresses a parameter for commands with arguments other than the address (KL, BS, SW, etc.).

The argument consists of ASCII alphabetic coded characters and digit characters.

## Communications interface manual

For detailed information on the serial interface commands, download the "BDP-V6000 Communications Interface Manual" from the Pioneer website.

# Licenses

The licenses for the software used on this player are shown below.

## ❖ libxml2

### The MIT License

Copyright © <year> <copyright holders>  
Permission is hereby granted, free of charge, to any person obtaining a copy of this software and associated documentation files (the "Software"), to deal in the Software without restriction, including without limitation the rights to use, copy, modify, merge, publish, distribute, sublicense, and/or sell copies of the Software, and to permit persons to whom the Software is furnished to do so, subject to the following conditions:  
The above copyright notice and this permission notice shall be included in all copies or substantial portions of the Software.

THE SOFTWARE IS PROVIDED "AS IS", WITHOUT WARRANTY OF ANY KIND, EXPRESS OR IMPLIED, INCLUDING BUT NOT LIMITED TO THE WARRANTIES OF MERCHANTABILITY, FITNESS FOR A PARTICULAR PURPOSE AND NONINFRINGEMENT. IN NO EVENT SHALL THE AUTHORS OR COPYRIGHT HOLDERS BE LIABLE FOR ANY CLAIM, DAMAGES OR OTHER LIABILITY, WHETHER IN AN ACTION OF CONTRACT, TORT OR OTHERWISE, ARISING FROM, OUT OF OR IN CONNECTION WITH THE SOFTWARE OR THE USE OR OTHER DEALINGS IN THE SOFTWARE.

## ❖ OpenSSL

The OpenSSL Toolkit stays under a dual license, i.e. both the conditions of the OpenSSL License and the original SSLeay license apply to the toolkit.

See below for the actual license texts. Actually both licenses are BSD-style Open Source licenses. In case of any license issues related to OpenSSL please contact openssl-core@openssl.org.

### OpenSSL License

Copyright © 1998-2007 The OpenSSL Project. All rights reserved.

Redistribution and use in source and binary forms, with or without modification, are permitted provided that the following conditions are met:

1. Redistributions of source code must retain the above copyright notice, this list of conditions and the following disclaimer.
2. Redistributions in binary form must reproduce the above copyright notice, this list of conditions and the following disclaimer in the documentation and/or other materials provided with the distribution.
3. All advertising materials mentioning features or use of this software must display the following acknowledgment: "This product includes software developed by the OpenSSL Project for use in the OpenSSL Toolkit. (<http://www.openssl.org/>)"
4. The names "OpenSSL Toolkit" and "OpenSSL Project" must not be used to endorse or promote products derived from this software without prior written permission. For written permission, please contact openssl-core@openssl.org.
5. Products derived from this software may not be called "OpenSSL" nor may "OpenSSL" appear in their names without prior written permission of the OpenSSL Project.
6. Redistributions of any form whatsoever must retain the following acknowledgment: "This product includes software developed by the OpenSSL Project for use in the OpenSSL Toolkit (<http://www.openssl.org/>)"

THIS SOFTWARE IS PROVIDED BY THE OPENSSL PROJECT "AS IS" AND ANY EXPRESSED OR IMPLIED WARRANTIES, INCLUDING, BUT NOT LIMITED TO, THE IMPLIED WARRANTIES OF MERCHANTABILITY AND FITNESS FOR A PARTICULAR PURPOSE ARE

DISCLAIMED. IN NO EVENT SHALL THE OPENSSL PROJECT OR ITS CONTRIBUTORS BE LIABLE FOR ANY DIRECT, INDIRECT, INCIDENTAL, SPECIAL, EXEMPLARY, OR CONSEQUENTIAL DAMAGES (INCLUDING, BUT NOT LIMITED TO, PROCUREMENT OF SUBSTITUTE GOODS OR SERVICES; LOSS OF USE, DATA, OR PROFITS; OR BUSINESS INTERRUPTION) HOWEVER CAUSED AND ON ANY THEORY OF LIABILITY, WHETHER IN CONTRACT, STRICT LIABILITY, OR TORT (INCLUDING NEGLIGENCE OR OTHERWISE) ARISING IN ANY WAY OUT OF THE USE OF THIS SOFTWARE, EVEN IF ADVISED OF THE POSSIBILITY OF SUCH DAMAGE.

This product includes cryptographic software written by Eric Young ([ey@cryptsoft.com](mailto:ey@cryptsoft.com)). This product includes software written by Tim Hudson ([tjh@cryptsoft.com](mailto:tjh@cryptsoft.com)).

### Original SSLeay License

Copyright © 1995-1998 Eric Young ([ey@cryptsoft.com](mailto:ey@cryptsoft.com))  
All rights reserved.

This package is an SSL implementation written by Eric Young ([ey@cryptsoft.com](mailto:ey@cryptsoft.com)). The implementation was written so as to conform with Netscapes SSL. This library is free for commercial and non-commercial use as long as the following conditions are adhered to. The following conditions apply to all code found in this distribution, be it the RC4, RSA, lhash, DES, etc., code; not just the SSL code. The SSL documentation included with this distribution is covered by the same copyright terms except that the holder is Tim Hudson ([tjh@cryptsoft.com](mailto:tjh@cryptsoft.com)). Copyright remains Eric Young's, and as such any Copyright notices in the code are not to be removed. If this package is used in a product, Eric Young should be given attribution as the author of the parts of the library used. This can be in the form of a textual message at program startup or in documentation (online or textual) provided with the package.

Redistribution and use in source and binary forms, with or without modification, are permitted provided that the following conditions are met:

1. Redistributions of source code must retain the copyright notice, this list of conditions and the following disclaimer.
2. Redistributions in binary form must reproduce the above copyright notice, this list of conditions and the following disclaimer in the documentation and/or other materials provided with the distribution.
3. All advertising materials mentioning features or use of this software must display the following acknowledgement: "This product includes cryptographic software written by Eric Young ([ey@cryptsoft.com](mailto:ey@cryptsoft.com))" The word 'cryptographic' can be left out if the routines from the library being used are not cryptographic related .)
4. If you include any Windows specific code (or a derivative thereof) from the apps directory (application code) you must include an acknowledgement: "This product includes software written by Tim Hudson ([tjh@cryptsoft.com](mailto:tjh@cryptsoft.com))"

THIS SOFTWARE IS PROVIDED BY ERIC YOUNG "AS IS" AND ANY EXPRESS OR IMPLIED WARRANTIES, INCLUDING, BUT NOT LIMITED TO, THE IMPLIED WARRANTIES OF MERCHANTABILITY AND FITNESS FOR A PARTICULAR PURPOSE ARE DISCLAIMED. IN NO EVENT SHALL THE AUTHOR OR CONTRIBUTORS BE LIABLE FOR ANY DIRECT, INDIRECT, INCIDENTAL, SPECIAL, EXEMPLARY, OR CONSEQUENTIAL DAMAGES (INCLUDING, BUT NOT LIMITED TO, PROCUREMENT OF SUBSTITUTE GOODS OR SERVICES; LOSS OF USE, DATA, OR PROFITS; OR BUSINESS INTERRUPTION) HOWEVER CAUSED AND ON ANY THEORY OF LIABILITY, WHETHER IN CONTRACT, STRICT LIABILITY, OR TORT (INCLUDING NEGLIGENCE OR OTHERWISE) ARISING IN ANY WAY OUT OF THE USE OF THIS SOFTWARE, EVEN IF ADVISED OF THE POSSIBILITY OF SUCH DAMAGE.

The license and distribution terms for any publically available version or derivative of this code cannot be changed. i.e. this code cannot simply be copied and put under another distribution licence [including the GNU Public Licence.]

## ❖ zlib

This software is based in part on zlib see <http://www.zlib.net> for information.

## ❖ FreeType2

### The FreeType Project LICENSE

2006-Jan-27 Copyright 1996-2002, 2006 by David Turner, Robert Wilhelm, and Werner Lemberg

#### Introduction

The FreeType Project is distributed in several archive packages; some of them may contain, in addition to the FreeType font engine, various tools and contributions which rely on, or relate to, the FreeType Project.

This license applies to all files found in such packages, and which do not fall under their own explicit license. The license affects thus the FreeType font engine, the test programs, documentation and makefiles, at the very least. This license was inspired by the BSD, Artistic, and IJG (Independent JPEG Group) licenses, which all encourage inclusion and use of free software in commercial and freeware products alike. As a consequence, its main points are that:

- We don't promise that this software works. However, we will be interested in any kind of bug reports. ('as is' distribution)
- You can use this software for whatever you want, in parts or full form, without having to pay us. ('royalty-free' usage)
- You may not pretend that you wrote this software. If you use it, or only parts of it, in a program, you must acknowledge somewhere in your documentation that you have used the FreeType code. ('credits')

We specifically permit and encourage the inclusion of this software, with or without modifications, in commercial products. We disclaim all warranties covering The FreeType

Project and assume no liability related to The FreeType Project.

Finally, many people asked us for a preferred form for a credit/disclaimer to use in compliance with this license. We thus encourage you to use the following text:

Portions of this software are copyright © <year> The FreeType Project ([www.freetype.org](http://www.freetype.org)). All rights reserved. Please replace <year> with the value from the FreeType version you actually use.

### Legal Terms

#### 0. Definitions

Throughout this license, the terms 'package', 'FreeType Project', and 'FreeType archive' refer to the set of files originally distributed by the authors (David Turner, Robert Wilhelm, and Werner Lemberg) as the 'FreeType Project', be they named as alpha, beta or final release. 'You' refers to the licensee, or person using the project, where 'using' is a generic term including compiling the project's source code as well as linking it to form a 'program' or 'executable'. This program is referred to as 'a program using the FreeType engine'.

This license applies to all files distributed in the original FreeType Project, including all source code, binaries and documentation, unless otherwise stated in the file in its original, unmodified form as distributed in the original archive. If you are unsure whether or not a particular file is covered by this license, you must contact us to verify this.

The FreeType Project is copyright (C) 1996-2000 by David Turner, Robert Wilhelm, and Werner Lemberg. All rights reserved except as specified below.

#### 1. No Warranty

THE FREETYPE PROJECT IS PROVIDED 'AS IS' WITHOUT WARRANTY OF ANY KIND, EITHER EXPRESS OR IMPLIED, INCLUDING, BUT NOT LIMITED TO, WARRANTIES OF MERCHANTABILITY AND FITNESS FOR A PARTICULAR PURPOSE. IN NO EVENT WILL ANY OF THE AUTHORS OR COPYRIGHT HOLDERS BE LIABLE FOR ANY DAMAGES CAUSED BY THE USE OR THE INABILITY TO USE, OF THE FREETYPE PROJECT.

#### 2. Redistribution

This license grants a worldwide, royalty-free, perpetual and irrevocable right and license to use, execute, perform, compile, display, copy, create derivative works of, distribute and sublicense the FreeType Project (in both source and object code forms) and derivative works thereof for any purpose; and to authorize others to exercise some or all of the rights granted herein, subject to the following conditions:

- Redistribution of source code must retain this license file ('FTL.TXT') unaltered; any additions, deletions or changes to the original files must be clearly indicated in accompanying documentation. The copyright notices of the unaltered, original files must be preserved in all copies of source files.
- Redistribution in binary form must provide a disclaimer that states that the software is based in part of the work of the FreeType Team, in the distribution documentation. We also encourage you to put an URL to the FreeType web page in your documentation, though this isn't mandatory.

These conditions apply to any software derived from or based on the FreeType Project, not just the unmodified files. If you use our work, you must acknowledge us.

However, no fee need be paid to us.

#### 3. Advertising

Neither the FreeType authors and contributors nor you shall use the name of the other for commercial, advertising, or promotional purposes without specific prior written permission.

We suggest, but do not require, that you use one or more of the following phrases to refer to this software in your documentation or advertising materials: 'FreeType Project', 'FreeType Engine', 'FreeType library', or 'FreeType Distribution'.

As you have not signed this license, you are not required to accept it. However, as the FreeType Project is copyrighted material, only this license, or another one contracted with the authors, grants you the right to use, distribute, and modify it. Therefore, by using, distributing, or modifying the FreeType Project, you indicate that you understand and accept all the terms of this license.

#### 4. Contacts

There are two mailing lists related to FreeType:

- [freetype@nongnu.org](mailto:freetype@nongnu.org)  
Discusses general use and applications of FreeType, as well as future and wanted additions to the library and distribution. If you are looking for support, start in this list if you haven't found anything to help you in the documentation.
- [freetype-devel@nongnu.org](mailto:freetype-devel@nongnu.org)  
Discusses bugs, as well as engine internals, design issues, specific licenses, porting, etc.

Our home page can be found at <http://www.freetype.org>

## ◆ libpng

COPYRIGHT NOTICE, DISCLAIMER, and LICENSE:

If you modify libpng you may insert additional notices immediately following this sentence.

libpng versions 1.2.6, August 15, 2004, through 1.2.26, April 3, 2008, are Copyright © 2004, 2006-2008 Glenn Randers-Pehrson, and are distributed according to the same disclaimer and license as libpng-1.2.5 with the following individual added to the list of Contributing Authors

Cosmin Truta  
libpng versions 1.0.7, July 1, 2000, through 1.2.5 - October 3, 2002, are Copyright © 2000-2002 Glenn Randers-Pehrson, and are distributed according to the same disclaimer and license as libpng-1.0.6 with the following individuals added to the list of Contributing Authors

Simon-Pierre Cadieux  
Eric S. Raymond  
Gilles Vollant

and with the following additions to the disclaimer:

There is no warranty against interference with your enjoyment of the library or against infringement. There is no warranty that our efforts or the library will fulfill any of your particular purposes or needs. This library is provided with all faults, and the entire risk of satisfactory quality, performance, accuracy, and effort is with the user.

libpng versions 0.97, January 1998, through 1.0.6, March 20, 2000, are Copyright © 1998, 1999 Glenn Randers-Pehrson, and are distributed according to the same disclaimer and license as libpng-0.96, with the following individuals added to the list of Contributing Authors:

Tom Lane  
Glenn Randers-Pehrson  
Willem van Schaik

libpng versions 0.89, June 1996, through 0.96, May 1997, are Copyright © 1996, 1997 Andreas Dilger Distributed according to the same disclaimer and license as libpng-0.88, with the following individuals added to the list of Contributing Authors:

John Bowler  
Kevin Bracey  
Sam Bushell  
Magnus Holmgren  
Greg Roelofs  
Tom Tanner

libpng versions 0.5, May 1995, through 0.88, January 1996, are Copyright © 1995, 1996 Guy Eric Schalnat, Group 42, Inc.

For the purposes of this copyright and license, "Contributing Authors" is defined as the following set of individuals:

Andreas Dilger  
Dave Martindale  
Guy Eric Schalnat  
Paul Schmidt  
Tim Wegner

The PNG Reference Library is supplied "AS IS". The Contributing Authors and Group 42, Inc. disclaim all warranties, expressed or implied, including, without limitation, the warranties of merchantability and of fitness for any purpose. The Contributing Authors and Group 42, Inc. assume no liability for direct, indirect, incidental, special, exemplary, or consequential damages, which may result from the use of the PNG Reference Library, even if advised of the possibility of such damage.

Permission is hereby granted to use, copy, modify, and distribute this source code, or portions hereof, for any purpose, without fee, subject to the following restrictions:

1. The origin of this source code must not be misrepresented.
2. Altered versions must be plainly marked as such and must not be misrepresented as being the original source.
3. This Copyright notice may not be removed or altered from any source or altered source distribution.

The Contributing Authors and Group 42, Inc. specifically permit, without fee, and encourage the use of this source code as a component to supporting the PNG file format in commercial products. If you use this source code in a product, acknowledgment is not required but would be appreciated.

A "png\_get\_copyright" function is available, for convenient use in "about" boxes and the like:

```
printf("%s",png_get_copyright(NULL));
```

Also, the PNG logo (in PNG format, of course) is supplied in the files "pngbar.png" and "pngbar.jpg (88x31)" and "pngnow.png" (98x31).

libpng is OSI Certified Open Source Software. OSI Certified Open Source is a certification mark of the Open Source Initiative.

Glenn Randers-Pehrson  
glennrp at users.sourceforge.net  
2-Apr-08

## ◆ libjpeg

The Independent JPEG Group's JPEG software

README for release 6b of 27-Mar-1998

This distribution contains the sixth public release of the Independent JPEG Group's free JPEG software. You are

welcome to redistribute this software and to use it for any purpose, subject to the conditions under LEGAL ISSUES, below.

Serious users of this software (particularly those incorporating it into larger programs) should contact IJG at jpeg-info@uunet.uu.net to be added to our electronic mailing list. Mailing list members are notified of updates and have a chance to participate in technical discussions, etc.

This software is the work of Tom Lane, Philip Gladstone, Jim Boucher, Lee Crocker, Julian Minguiillon, Luis Ortiz, George Phillips, Davide Rossi, Guido Vollbeding, Ge' Weijers, and other members of the Independent JPEG Group. IJG is not affiliated with the official ISO JPEG standards committee.

### DOCUMENTATION ROADMAP

This file contains the following sections:

**OVERVIEW** General description of JPEG and the IJG software.  
**LEGAL ISSUES** Copyright, lack of warranty, terms of distribution.  
**REFERENCES** Where to learn more about JPEG.  
**ARCHIVE LOCATIONS** Where to find newer versions of this software.

**RELATED SOFTWARE** Other stuff you should get.

**FILE FORMAT WARS** Software "not" to get.

**TO DO** Plans for future IJG releases.

Other documentation files in the distribution are:

User documentation:

install.doc	How to configure and install the IJG software.
usage.doc	Usage instructions for cjpeg, djpeg, jpegtran, rdjpgcom, and wrjpgcom.
*.1 Unix-style man pages for programs (same info as usage.doc).	
wizard.doc	Advanced usage instructions for JPEG wizards only.
change.log	Version-to-version change highlights.
Programmer and libjpeg.doc	internal documentation: How to use the JPEG library in your own programs.
example.c	Sample code for calling the JPEG library.
structure.doc	Overview of the JPEG library's internal structure.
filelist.doc	Road map of IJG files.
coderule.doc	Coding style rules --- please read if you contribute code.

Please read at least the files install.doc and usage.doc. Useful information can also be found in the JPEG FAQ (Frequently Asked Questions) article. See ARCHIVE LOCATIONS below to find out where to obtain the FAQ article.

If you want to understand how the JPEG code works, we suggest reading one or more of the REFERENCES, then looking at the documentation files (in roughly the order listed) before diving into the code.

### OVERVIEW

This package contains C software to implement JPEG image compression and decompression. JPEG (pronounced "jay-peg") is a standardized compression method for full-color and gray-scale images. JPEG is intended for compressing real-world scenes; line drawings, cartoons and other non-realistic images are not its strong suit. JPEG is lossy, meaning that the output image is not exactly identical to the input image. Hence you must not use JPEG if you have to have identical output bits. However, on typical photographic images, very good compression levels can be obtained with no visible change, and remarkably high compression levels are possible if you can tolerate a low-quality image. For more details, see the references, or just experiment with various compression settings.

This software implements JPEG baseline, extended-sequential, and progressive compression processes. Provision is made for supporting all variants of these processes, although some uncommon parameter settings aren't implemented yet. For legal reasons, we are not distributing code for the arithmetic-coding variants of JPEG; see LEGAL ISSUES. We have made no provision for supporting the hierarchical or lossless processes defined in the standard.

We provide a set of library routines for reading and writing JPEG image files, plus two sample applications "cjpeg" and "djpeg", which use the library to perform conversion between JPEG and some other popular image file formats. The library is intended to be reused in other applications.

In order to support file conversion and viewing software, we have included considerable functionality beyond the bare JPEG coding/decoding capability; for example, the color quantization modules are not strictly part of JPEG decoding, but they are essential for output to colormapped file formats or colormapped displays. These extra functions can be compiled out of the library if not required for a particular application. We have also included jpegtran, a utility for lossless transcoding between different JPEG processes, and "rdjpgcom" and "wrjpgcom", two simple

applications for inserting and extracting textual comments in JFIF files.

The emphasis in designing this software has been on achieving portability and flexibility, while also making it fast enough to be useful. In particular, the software is not intended to be read as a tutorial on JPEG. (See the REFERENCES section for introductory material.) Rather, it is intended to be reliable, portable, industrial-strength code. We do not claim to have achieved that goal in every aspect of the software, but we strive for it.

We welcome the use of this software as a component of commercial products. No royalty is required, but we do ask for an acknowledgement in product documentation, as described under LEGAL ISSUES.

### LEGAL ISSUES

In plain English:

1. We don't promise that this software works. (But if you find any bugs, please let us know!)
2. You can use this software for whatever you want. You don't have to pay us.
3. You may not pretend that you wrote this software. If you use it in a program, you must acknowledge somewhere in your documentation that you've used the IJG code.

In legalese:

The authors make NO WARRANTY or representation, either express or implied, with respect to this software, its quality, accuracy, merchantability, or fitness for a particular purpose. This software is provided "AS IS", and you, its user, assume the entire risk as to its quality and accuracy. This software is copyright © 1991-1998, Thomas G. Lane. All Rights Reserved except as specified below.

Permission is hereby granted to use, copy, modify, and distribute this software (or portions thereof) for any purpose, without fee, subject to these conditions:

- (1) If any part of the source code for this software is distributed, then this README file must be included, with this copyright and no-warranty notice unaltered; and any additions, deletions, or changes to the original files must be clearly indicated in accompanying documentation.

- (2) If only executable code is distributed, then the accompanying documentation must state that "this software is based in part on the work of the Independent JPEG Group".

- (3) Permission for use of this software is granted only if the user accepts full responsibility for any undesirable consequences; the authors accept NO LIABILITY for damages of any kind.

These conditions apply to any software derived from or based on the IJG code, not just to the unmodified library. If you use our work, you ought to acknowledge us.

Permission is NOT granted for the use of any IJG author's name or company name in advertising or publicity relating to this software or products derived from it. This software may be referred to only as "the Independent JPEG Group's software".

We specifically permit and encourage the use of this software as the basis of commercial products, provided that all warranty or liability claims are assumed by the product vendor.

ansi2kncr.c is included in this distribution by permission of L. Peter Deutsch, sole proprietor of its copyright holder, Aladdin Enterprises of Menlo Park, CA. ansi2kncr.c is NOT covered by the above copyright and conditions, but instead by the usual distribution terms of the Free Software Foundation; principally, that you must include source code if you redistribute it. (See the file ansi2kncr.c for full details.)

However, since ansi2kncr.c is not needed as part of any program generated from the IJG code, this does not limit you more than the foregoing paragraphs do.

The Unix configuration script "configure" was produced with GNU Autoconf. It is copyright by the Free Software Foundation but is freely distributable. The same holds for its supporting scripts (config.guess, config.sub, lconfig, ltmain.sh). Another support script, install-sh, is copyright by M.I.T. but is also freely distributable.

It appears that the arithmetic coding option of the JPEG spec is covered by patents owned by IBM, AT&T, and Mitsubishi. Hence arithmetic coding cannot legally be used without obtaining one or more licenses. For this reason, support for arithmetic coding has been removed from the free JPEG software. (Since arithmetic coding provides only a marginal gain over the unpatented Huffman mode, it is unlikely that very many implementations will support it.) So far as we are aware, there are no patent restrictions on the remaining code.

The IJG distribution formerly included code to read and write GIF files. To avoid entanglement with the Unisys LZW patent, GIF reading support has been removed altogether, and the GIF writer has been simplified to produce uncompressed GIFs. This technique does not use the LZW algorithm; the resulting GIF files are larger than usual, but are readable by all standard GIF decoders.

We are required to state that

"The Graphics Interchange Format(c) is the Copyright property of CompuServe Incorporated. GIF(sm) is a Service Mark property of CompuServe Incorporated."

#### REFERENCES

We highly recommend reading one or more of these references before trying to understand the innards of the JPEG software.

The best short technical introduction to the JPEG compression algorithm is

Wallace, Gregory K. "The JPEG Still Picture Compression Standard",

Communications of the ACM, April 1991 (vol. 34 no. 4), pp. 30-44.

(Adjacent articles in that issue discuss MPEG motion picture compression, applications of JPEG, and related topics.) If you don't have the CACM issue handy, a PostScript file containing a revised version of Wallace's article is available at [ftp://ftp.uu.net/graphics/jpeg/wallace.ps.gz](http://ftp.uu.net/graphics/jpeg/wallace.ps.gz). The file (actually a preprint for an article that appeared in IEEE Trans. Consumer Electronics) omits the sample images that appeared in CACM, but it includes corrections and some added material. Note: the Wallace article is copyright ACM and IEEE, and it may not be used for commercial purposes.

A somewhat less technical, more leisurely introduction to JPEG can be found in *The Data Compression Book* by Mark Nelson and Jean-loup Gailly, published by M&T Books (New York), 2nd ed. 1996, ISBN 1-55851-434-1. This book provides good explanations and example C code for a multitude of compression methods including JPEG. It is an excellent source if you are comfortable reading C code but don't know much about data compression in general. The book's JPEG sample code is far from industrial-strength, but when you are ready to look at a full implementation, you've got one here...

The best full description of JPEG is the textbook "JPEG Still Image Data Compression Standard" by William B. Pennebaker and Joan L. Mitchell, published by Van Nostrand Reinhold, 1993, ISBN 0-442-01272-1. Price US\$59.95, 638 pp. The book includes the complete text of the ISO JPEG standards (DIS 10918-1 and draft DIS 10918-2). This is by far the most complete exposition of JPEG in existence, and we highly recommend it.

The JPEG standard itself is not available electronically; you must order a paper copy through ISO or ITU. (Unless you feel a need to own a certified official copy, we recommend buying the Pennebaker and Mitchell book instead; it's much cheaper and includes a great deal of useful explanatory material.) In the USA, copies of the standard may be ordered from ANSI Sales at (212) 642-4900, or from Global Engineering Documents at (800) 854-7179. (ANSI doesn't take credit card orders, but Global does.) It's not cheap: as of 1992, ANSI was charging \$95 for Part 1 and \$47 for Part 2, plus 7% shipping/handling. The standard is divided into two parts, Part 1 being the actual specification, while Part 2 covers compliance testing methods. Part 1 is titled "Digital Compression and Coding of Continuous-tone Still Images, Part 1: Requirements and guidelines" and has document numbers ISO/IEC IS 10918-1, ITU-T.T.81. Part 2 is titled "Digital Compression and Coding of Continuous-tone Still Images, Part 2: Compliance testing" and has document numbers ISO/IEC IS 10918-2, ITU-T.T.83.

Some extensions to the original JPEG standard are defined in JPEG Part 3, a newer ISO standard numbered ISO/IEC IS 10918-3 and ITU-T.T.84. IJG currently does not support any Part 3 extensions.

The JPEG standard does not specify all details of an interchangeable file format. For the omitted details we follow the "JFIF" conventions, revision 1.02. A copy of the JFIF spec is available from:

Literature Department  
C.Cube Microsystems, Inc.  
1778 McCarthy Blvd.  
Milpitas, CA 95035  
phone (408) 944-6300, fax (408) 944-6314

A PostScript version of this document is available by FTP at <ftp://ftp.uu.net/graphics/jpeg/jfif.ps.gz>. There is also a plain text version at <ftp://ftp.uu.net/graphics/jpeg/jfif.txt.gz>, but it is missing the figures.

The TIFF 6.0 file format specification can be obtained by FTP from <ftp://ftp.sgi.com/graphics/tiff/TIFF6.ps.gz>. The JPEG incorporation scheme found in the TIFF 6.0 spec of 3-June-92 has a number of serious problems. IJG does not recommend use of the TIFF 6.0 design (TIFF Compression tag 6). Instead, we recommend the JPEG design proposed by TIFF Technical Note #2 (Compression tag 7). Copies of this Note can be obtained from <ftp.sgi.com> or from <ftp://ftp.uu.net/graphics/jpeg/>. It is expected that the next revision of the TIFF spec will replace the 6.0 JPEG design with the Note's design. Although IJG's own code does not support TIFF/JPEG, the free libtiff library uses our library to implement TIFF/JPEG per the Note. libtiff is available from <ftp://ftp.sgi.com/graphics/tiff/>.

#### ARCHIVE LOCATIONS

The "official" archive site for this software is <ftp.uu.net> (Internet address 192.48.96.9). The most recent released

version can always be found there in directory `graphics/jpeg`. This particular version will be archived as <ftp://ftp.uu.net/graphics/jpeg/pegsrvc.v6b.tar.gz>. If you don't have direct Internet access, UUNET's archives are also available via UUCP; contact help@uunet.uu.net for information on retrieving files that way. Numerous Internet sites maintain copies of the UUNET files. However, only <ftp.uu.net> is guaranteed to have the latest official version.

You can also obtain this software in DOS-compatible "zip" archive format from the SimTel archives (<ftp://ftp.simtel.net/pub/simtelnet/msdos/graphics/>), or on CompuServe in the Graphics Support forum (GO CIS:GRAPHSUP), library 12 JPEG Tools. Again, these versions may sometimes lag behind the <ftp.uu.net> release. The JPEG FAQ (Frequently Asked Questions) article is a useful source of general information about JPEG. It is updated constantly and therefore is not included in this distribution. The FAQ is posted every two weeks to Usenet newsgroups `comp.graphics.misc`, `news.answers`, and other groups. It is available on the World Wide Web at <http://www.faqs.org/faqs/jpeg-faq/> and other `news.answers` archive sites, including the official `news.answers` archive at <rtfm.mit.edu>: <ftp://rtfm.mit.edu/pub/usenet/news.answers/jpeg-faq/>. If you don't have Web or FTP access, send e-mail to [mail-server@rtfm.mit.edu](mailto:mail-server@rtfm.mit.edu) with body

```
send usenet/news.answers/jpeg-faq/part1
send usenet/news.answers/jpeg-faq/part2
```

#### RELATED SOFTWARE

Numerous viewing and image manipulation programs now support JPEG. (Quite a few of them use this library to do so.) The JPEG FAQ described above lists some of the more popular free and shareware viewers, and tells where to obtain them on Internet.

If you are on a Unix machine, we highly recommend Jef Poskanzer's free PBMPLUS software, which provides many useful operations on PPM-format image files. In particular, it can convert PPM images to and from a wide range of other formats, thus making `cjpeg`/`djpeg` considerably more useful. The latest version is distributed by the NetPBM group, and is available from numerous sites, notably <ftp://wuarhive.wustl.edu/graphics/packages/NetPBM/>. Unfortunately PBMPLUS/NETPBM is not nearly as portable as the IJG software is; you are likely to have difficulty making it work on any non-Unix machine. A different free JPEG implementation, written by the PVRG group at Stanford, is available from <ftp://havefun.stanford.edu/pub/jpeg/>. This program is designed for research and experimentation rather than production use; it is slower, harder to use, and less portable than the IJG code, but it is easier to read and modify. Also, the PVRG code supports lossless JPEG, which we do not. (On the other hand, it doesn't do progressive JPEG.)

#### FILE FORMAT WARS

Some JPEG programs produce files that are not compatible with our library. The root of the problem is that the ISO JPEG committee failed to specify a concrete file format. Some vendors "filled in the blanks" on their own, creating proprietary formats that no one else could read. (For example, none of the early commercial JPEG implementations for the Macintosh were able to exchange compressed files.)

The file format we have adopted is called JFIF (see REFERENCES). This format has been agreed to by a number of major commercial JPEG vendors, and it has become the de facto standard. JFIF is a minimal or "low end" representation. We recommend the use of TIFF/JPEG (TIFF revision 6.0 as modified by TIFF Technical Note #2) for "high end" applications that need to record a lot of additional data about an image. TIFF/JPEG is fairly new and not yet widely supported, unfortunately.

The upcoming JPEG Part 3 standard defines a file format called SPIFF. SPIFF is interoperable with JFIF, in the sense that most JFIF decoders should be able to read the most common variant of SPIFF. SPIFF has some technical advantages over JFIF, but its major claim to fame is simply that it is an official standard rather than an informal one. At this point it is unclear whether SPIFF will supersede JFIF or whether JFIF will remain the de-facto standard. IJG intends to support SPIFF once the standard is frozen, but we have not decided whether it should become our default output format or not. (In any case, our decoder will remain capable of reading JFIF indefinitely.)

Various proprietary file formats incorporating JPEG compression also exist. We have little or no sympathy for the existence of these formats. Indeed, one of the original reasons for developing this free software was to help force convergence on common, open format standards for JPEG files. Don't use a proprietary file format!

#### TO DO

The major thrust for v7 will probably be improvement of visual quality. The current method for scaling the quantization tables is known not to be very good at low Q values. We also intend to investigate block boundary smoothing, "poor man's variable quantization", and other

means of improving quality-vs-file-size performance without sacrificing compatibility.

In future versions, we are considering supporting some of the upcoming JPEG Part 3 extensions -- principally, variable quantization and the SPIFF file format. As always, speeding things up is of great interest. Please send bug reports, offers of help, etc. to [jpeg-info@uunet.uu.net](mailto:jpeg-info@uunet.uu.net).

## ◆ libupnp

Copyright (c) 2000-2003 Intel Corporation  
All rights reserved.

Redistribution and use in source and binary forms, without modification, are permitted provided that the following conditions are met:

- \* Redistributions of source code must retain the above copyright notice, this list of conditions and the following disclaimer.
- \* Redistributions in binary form must reproduce the above copyright notice, this list of conditions and the following disclaimer in the documentation and/or other materials provided with the distribution.
- \* Neither name of Intel Corporation nor the names of its contributors may be used to endorse or promote products derived from this software without specific prior written permission.

THIS SOFTWARE IS PROVIDED BY THE COPYRIGHT HOLDERS AND CONTRIBUTORS

"AS IS" AND ANY EXPRESS OR IMPLIED WARRANTIES, INCLUDING, BUT NOT LIMITED TO, THE IMPLIED WARRANTIES OF MERCHANTABILITY AND FITNESS FOR A PARTICULAR PURPOSE ARE DISCLAIMED. IN NO EVENT SHALL INTEL OR CONTRIBUTORS BE LIABLE FOR ANY DIRECT, INDIRECT, INCIDENTAL, SPECIAL, EXEMPLARY, OR CONSEQUENTIAL DAMAGES (INCLUDING, BUT NOT LIMITED TO, PROCUREMENT OF SUBSTITUTE GOODS OR SERVICES; LOSS OF USE, DATA, OR PROFITS; OR BUSINESS INTERRUPTION) HOWEVER CAUSED AND ON ANY THEORY OF LIABILITY, WHETHER IN CONTRACT, STRICT LIABILITY, OR TORT (INCLUDING NEGLIGENCE OR OTHERWISE) ARISING IN ANY WAY OUT OF THE USE OF THIS SOFTWARE, EVEN IF ADVISED OF THE POSSIBILITY OF SUCH DAMAGE.

## ◆ AVC/H.264

THIS PRODUCT IS LICENSED UNDER THE AVC PATENT PORTFOLIO LICENSE FOR THE PERSONAL AND NON-COMMERCIAL USE OF A CONSUMER TO (i) ENCODE VIDEO IN COMPLIANCE WITH THE AVC STANDARD ("AVC VIDEO") AND/OR (ii) DECODE AVC VIDEO THAT WAS ENCODED BY A CONSUMER ENGAGED IN A PERSONAL AND NON-COMMERCIAL ACTIVITY AND/OR WAS OBTAINED FROM A VIDEO PROVIDER LICENSED TO PROVIDE AVC VIDEO. NO LICENSE IS GRANTED OR SHALL BE IMPLIED FOR ANY OTHER USE. ADDITIONAL INFORMATION MAY BE OBTAINED FROM MPEG LA, L.L.C. SEE [HTTP://MPEGLA.COM](http://MPEGLA.COM).

## ◆ GNU GENERAL PUBLIC LICENSE

Version 2, June 1991  
Copyright © 1989, 1991 Free Software Foundation, Inc., 51 Franklin Street, Fifth Floor, Boston, MA 02110-1301 USA  
Everyone is permitted to copy and distribute verbatim copies of this license document, but changing it is not allowed.

#### Preamble

The licenses for most software are designed to take away your freedom to share and change it. By contrast, the GNU General Public License is intended to guarantee your freedom to share and change free software - to make sure the software is free for all its users. This General Public License applies to most of the Free Software Foundation's software and to any other program whose authors commit to using it. (Some other Free Software Foundation software is covered by the GNU Lesser General Public License instead.) You can apply it to your programs, too.

When we speak of free software, we are referring to freedom, not price. Our General Public Licenses are designed to make sure that you have the freedom to distribute copies of free software (and charge for this service if you wish), that you receive source code or can get it if you want it, that you can change the software or use pieces of it in new free programs; and that you know you can do these things.

To protect your rights, we need to make restrictions that forbid anyone to deny you these rights or to ask you to surrender the rights. These restrictions translate to certain responsibilities for you if you distribute copies of the software, or if you modify it.

For example, if you distribute copies of such a program, whether gratis or for a fee, you must give the recipients all the rights that you have. You must make sure that they, too, receive or can get the source code. And you must show them these terms so they know their rights.

We protect your rights with two steps: (1) copyright the software, and (2) offer you this license which gives you legal permission to copy, distribute and/or modify the software. Also, for each author's protection and ours, we want to make certain that everyone understands that there is no warranty for this free software. If the software is modified by someone else and passed on, we want its recipients to know that what they have is not the original, so that any problems introduced by others will not reflect on the original authors' reputations.

Finally, any free program is threatened constantly by software patents. We wish to avoid the danger that redistributors of a free program will individually obtain patent licenses, in effect making the program proprietary. To prevent this, we have made it clear that any patent must be licensed for everyone's free use or not licensed at all. The precise terms and conditions for copying, distribution and modification follow.

#### TERMS AND CONDITIONS FOR COPYING, DISTRIBUTION AND MODIFICATION

0. This License applies to any program or other work which contains a notice placed by the copyright holder saying it may be distributed under the terms of this General Public License. The "Program", below, refers to any such program or work, and a "work based on the Program" means either the Program or any derivative work under copyright law: that is to say, a work containing the Program or a portion of it, either verbatim or with modifications and/or translated into another language. (Hereinafter, translation is included without limitation in the term "modification".) Each licensee is addressed as "you".

Activities other than copying, distribution and modification are not covered by this License; they are outside its scope. The act of running the Program is not restricted, and the output from the Program is covered only if its contents constitute a work based on the Program (independent of having been made by running the Program). Whether that is true depends on what the Program does.

1. You may copy and distribute verbatim copies of the Program's source code as you receive it, in any medium, provided that you conspicuously and appropriately publish on each copy an appropriate copyright notice and disclaimer of warranty; keep intact all the notices that refer to this License and to the absence of any warranty; and give any other recipients of the Program a copy of this License along with the Program. You may charge a fee for the physical act of transferring a copy, and you may at your option offer warranty protection in exchange for a fee.
2. You may modify your copy or copies of the Program or any portion of it, thus forming a work based on the Program, and copy and distribute such modifications or work under the terms of Section 1 above, provided that you also meet all of these conditions:
  - a) You must cause the modified files to carry prominent notices stating that you changed the files and the date of any change.
  - b) You must cause any work that you distribute or publish, that in whole or in part contains or is derived from the Program or any part thereof, to be licensed as a whole at no charge to all third parties under the terms of this License.
  - c) If the modified program normally reads commands interactively when run, you must cause it, when started running for such interactive use in the most ordinary way, to print or display an announcement including an appropriate copyright notice and a notice that there is no warranty (or else, saying that you provide a warranty) and that users may redistribute the program under these conditions, and telling the user how to view a copy of this License. (Exception: if the Program itself is interactive but does not normally print such an announcement, your work based on the Program is not required to print an announcement.)

These requirements apply to the modified work as a whole. If identifiable sections of that work are not derived from the Program, and can be reasonably considered independent and separate works in themselves, then this License, and its terms, do not apply to those sections when you distribute them as separate works. But when you distribute the same sections as part of a whole which is a work based on the Program, the distribution of the whole must be on the terms of this License, whose permissions for other licensees extend to the entire whole, and thus to each and every part regardless of who wrote it.

Thus, it is not the intent of this section to claim rights or contest your rights to work written entirely by you; rather, the intent is to exercise the right to control the distribution of derivative or collective works based on the Program.

In addition, mere aggregation of another work not based on the Program with the Program (or with a work based on the Program) on a volume of a storage or distribution

medium does not bring the other work under the scope of this License.

3. You may copy and distribute the Program (or a work based on it, under Section 2) in object code or executable form under the terms of Sections 1 and 2 above provided that you also do one of the following:
  - a) Accompany it with the complete corresponding machine-readable source code, which must be distributed under the terms of Sections 1 and 2 above on a medium customarily used for software interchange; or,
  - b) Accompany it with a written offer, valid for at least three years, to give any third party, for a charge no more than your cost of physically performing source distribution, a complete machine-readable copy of the corresponding source code, to be distributed under the terms of Sections 1 and 2 above on a medium customarily used for software interchange; or,
  - c) Accompany it with the information you received as to the offer to distribute corresponding source code. (This alternative is allowed only for noncommercial distribution and only if you received the program in object code or executable form with such an offer, in accord with Subsection b above.)

The source code for a work means the preferred form of the work for making modifications to it. For an executable work, complete source code means all the source code for all modules it contains, plus any associated interface definition files, plus the scripts used to control compilation and installation of the executable. However, as a special exception, the source code distributed need not include anything that is normally distributed (in either source or binary form) with the major components (compiler, kernel, and so on) of the operating system on which the executable runs, unless that component itself accompanies the executable.

If distribution of executable or object code is made by offering access to copy from a designated place, then offering equivalent access to copy the source code from the same place counts as distribution of the source code, even though third parties are not compelled to copy the source along with the object code.

4. You may not copy, modify, sublicense, or distribute the Program except as expressly provided under this License. Any attempt otherwise to copy, modify, sublicense or distribute the Program is void, and will automatically terminate your rights under this License. However, parties who have received copies, or rights, from you under this License will not have their licenses terminated so long as such parties remain in full compliance.
5. You are not required to accept this License, since you have not signed it. However, nothing else grants you permission to modify or distribute the Program or its derivative works. These actions are prohibited by law if you do not accept this License. Therefore, by modifying or distributing the Program (or any work based on the Program), you indicate your acceptance of this License to do so, and all its terms and conditions for copying, distributing or modifying the Program or works based on it.
6. Each time you redistribute the Program (or any work based on the Program), the recipient automatically receives a license from the original licensor to copy, distribute or modify the Program subject to these terms and conditions. You may not impose any further restrictions on the recipients' exercise of the rights granted herein. You are not responsible for enforcing compliance by third parties to this License.
7. If, as a consequence of a court judgment or allegation of patent infringement or for any other reason (not limited to patent issues), conditions are imposed on you (whether by court order, agreement or otherwise) that contradict the conditions of this License, they do not excuse you from the conditions of this License. If you cannot distribute so as to satisfy simultaneously your obligations under this License and any other pertinent obligations, then as a consequence you may not distribute the Program at all. For example, if a patent license would not permit royalty-free redistribution of the Program by all those who receive copies directly or indirectly through you, then the only way you could satisfy both it and this License would be to refrain entirely from distribution of the Program. If any portion of this section is held invalid or unenforceable under any particular circumstance, the balance of the section is intended to apply and the section as a whole is intended to apply in other circumstances. It is not the purpose of this section to induce you to infringe any patents or other property right claims or to contest validity of any such claims; this section has the sole purpose of protecting the integrity of the free software distribution system, which is implemented by public license practices. Many people have made

generous contributions to the wide range of software distributed through that system in reliance on consistent application of that system; it is up to the author/donor to decide if he or she is willing to distribute software through any other system and a licensee cannot impose that choice.

This section is intended to make thoroughly clear what is believed to be a consequence of the rest of this License.

8. If the distribution and/or use of the Program is restricted in certain countries either by patents or by copyrighted interfaces, the original copyright holder who places the Program under this License may add an explicit geographical distribution limitation excluding those countries, so that distribution is permitted only in or among countries not thus excluded. In such case, this License incorporates the limitation as if written in the body of this License.
9. The Free Software Foundation may publish revised and/or new versions of the General Public License from time to time. Such new versions will be similar in spirit to the present version, but may differ in detail to address new problems or concerns. Each version is given a distinguishing version number. If the Program specifies a version number of this License which applies to it and "any later version", you have the option of following the terms and conditions either of that version or of any later version published by the Free Software Foundation. If the Program does not specify a version number of this License, you may choose any version ever published by the Free Software Foundation.
10. If you wish to incorporate parts of the Program into other free programs whose distribution conditions are different, write to the author to ask for permission. For software which is copyrighted by the Free Software Foundation, write to the Free Software Foundation; we sometimes make exceptions for this. Our decision will be guided by the two goals of preserving the free status of all derivatives of our free software and of promoting the sharing and reuse of software generally.

#### NO WARRANTY

11. BECAUSE THE PROGRAM IS LICENSED FREE OF CHARGE, THERE IS NO WARRANTY FOR THE PROGRAM, TO THE EXTENT PERMITTED BY APPLICABLE LAW. EXCEPT WHEN OTHERWISE STATED IN WRITING THE COPYRIGHT HOLDERS AND/OR OTHER PARTIES PROVIDE THE PROGRAM "AS IS" WITHOUT WARRANTY OF ANY KIND, EITHER EXPRESSED OR IMPLIED, INCLUDING, BUT NOT LIMITED TO, THE IMPLIED WARRANTIES OF MERCHANTABILITY AND FITNESS FOR A PARTICULAR PURPOSE. THE ENTIRE RISK AS TO THE QUALITY AND PERFORMANCE OF THE PROGRAM IS WITH YOU. SHOULD THE PROGRAM PROVE DEFECTIVE, YOU ASSUME THE COST OF ALL NECESSARY SERVICING, REPAIR OR CORRECTION.

12. IN NO EVENT UNLESS REQUIRED BY APPLICABLE LAW OR AGREED TO IN WRITING WILL ANY COPYRIGHT HOLDER, OR ANY OTHER PARTY WHO MAY MODIFY AND/OR REDISTRIBUTE THE PROGRAM AS PERMITTED ABOVE, BE LIABLE TO YOU FOR DAMAGES, INCLUDING ANY GENERAL, SPECIAL, INCIDENTAL OR CONSEQUENTIAL DAMAGES ARISING OUT OF THE USE OR INABILITY TO USE THE PROGRAM (INCLUDING BUT NOT LIMITED TO LOSS OF DATA OR DATA BEING RENDERED INACCURATE OR LOSSES SUSTAINED BY YOU OR THIRD PARTIES OR A FAILURE OF THE PROGRAM TO OPERATE WITH ANY OTHER PROGRAMS), EVEN IF SUCH HOLDER OR OTHER PARTY HAS BEEN ADVISED OF THE POSSIBILITY OF SUCH DAMAGES.

#### END OF TERMS AND CONDITIONS

##### How to Apply These Terms to Your New Programs

If you develop a new program, and you want it to be of the greatest possible use to the public, the best way to achieve this is to make it free software which everyone can redistribute and change under these terms.

To do so, attach the following notices to the program. It is safest to attach them to the start of each source file to most effectively convey the exclusion of warranty; and each file should have at least the "copyright" line and a pointer to where the full notice is found.

< one line to give the program's name and a brief idea of what it does.>

Copyright © <year> <name of author>

This program is free software; you can redistribute it and/or modify it under the terms of the GNU General Public License as published by the Free Software Foundation; either version 2 of the License, or (at your option) any later version.

This program is distributed in the hope that it will be useful, but WITHOUT ANY WARRANTY; without even the implied warranty of MERCHANTABILITY or FITNESS FOR A PARTICULAR PURPOSE. See the GNU General Public License for more details.

You should have received a copy of the GNU General Public License along with this program; if not, write to



the Free Software Foundation, Inc., 51 Franklin Street, Fifth Floor, Boston, MA 02110-1301 USA.

Also add information on how to contact you by electronic and paper mail.

If the program is interactive, make it output a short notice like this when it starts in an interactive mode:

```
Gnomovision version 69, Copyright © year name of author
```

```
Gnomovision comes with ABSOLUTELY NO WARRANTY; for details type 'show w'. This is free software, and you are welcome to redistribute it under certain conditions; type 'show c' for details.
```

The hypothetical commands 'show w' and 'show c' should show the appropriate parts of the General Public License. Of course, the commands you use may be called something other than 'show w' and 'show c'; they could even be mouse-clicks or menu items - whatever suits your program.

You should also get your employer (if you work as a programmer) or your school, if any, to sign a "copyright disclaimer" for the program, if necessary. Here is a sample; after the names:

```
Yoodyne, Inc., hereby disclaims all copyright interest in the program "Gnomovision" (which makes passes at compilers) written by James Hacker.
```

```
<signature of Ty Coon>, 1 April 1989
```

```
Ty Coon, President of Vice
```

This General Public License does not permit incorporating your program into proprietary programs. If your program is a subroutine library, you may consider it more useful to permit linking proprietary applications with the library. If this is what you want to do, use the GNU Lesser General Public License instead of this License.

## ❖ GNU LESSER GENERAL PUBLIC LICENSE

Version 2.1, February 1999

Copyright © 1991, 1999 Free Software Foundation, Inc. 51 Franklin Street, Fifth Floor, Boston, MA 02110-1301 USA Everyone is permitted to copy and distribute verbatim copies of this license document, but changing it is not allowed.

[This is the first released version of the Lesser GPL. It also counts as the successor of the GNU Library Public License, version 2, hence the version number 2.1.]

### Preamble

The licenses for most software are designed to take away your freedom to share and change it. By contrast, the GNU General Public Licenses are intended to guarantee your freedom to share and change free software - to make sure the software is free for all its users. This license, the Lesser General Public License, applies to some specially designated software packages - typically libraries - of the Free Software Foundation and other authors who decide to use it. You can use it too, but we suggest you first think carefully about whether this license or the ordinary General Public License is the better strategy to use in any particular case, based on the explanations below.

When we speak of free software, we are referring to freedom of use, not price. Our General Public Licenses are designed to make sure that you have the freedom to distribute copies of free software (and charge for this service if you wish); that you receive source code or can get it if you want it; that you can change the software and use pieces of it in new free programs; and that you are informed that you can do these things.

To protect your rights, we need to make restrictions that forbid distributors to deny you these rights or to ask you to surrender these rights. These restrictions translate to certain responsibilities for you if you distribute copies of the library or if you modify it.

For example, if you distribute copies of the library, whether gratis or for a fee, you must give the recipients all the rights that we gave you. You must make sure that they, too, receive or can get the source code. If you link other code with the library, you must provide complete object files to the recipients, so that they can relink them with the library after making changes to the library and recompiling it. And you must show them these terms so they know their rights. We protect your rights with a two-step method: (1) we copyright the library, and (2) we offer you this license, which gives you legal permission to copy, distribute and/or modify the library.

To protect each distributor, we want to make it very clear that there is no warranty for the free library. Also, if the library is modified by someone else and passed on, the recipients should know that what they have is not the original version, so that the original author's reputation will not be affected by problems that might be introduced by others.

Finally, software patents pose a constant threat to the existence of any free program. We wish to make sure that a company cannot effectively restrict the users of a free program by obtaining a restrictive license from a patent holder. Therefore, we insist that any patent license obtained

for a version of the library must be consistent with the full freedom of use specified in this license.

Most GNU software, including some libraries, is covered by the ordinary GNU General Public License. This license, the GNU Lesser General Public License, applies to certain designated libraries, and is quite different from the ordinary General Public License. We use this license for certain libraries in order to permit linking those libraries into non-free programs.

When a program is linked with a library, whether statically or using a shared library, the combination of the two is legally speaking a combined work, a derivative of the original library. The ordinary General Public License therefore permits such linking only if the entire combination fits its criteria of freedom. The Lesser General Public License permits more lax criteria for linking other code with the library.

We call this license the "Lesser" General Public License because it does Less to protect the user's freedom than the ordinary General Public License. It also provides other free software developers Less of an advantage over competing non-free programs. These disadvantages are the reason we use the ordinary General Public License for many libraries. However, the Lesser license provides advantages in certain special circumstances.

For example, on rare occasions, there may be a special need to encourage the widest possible use of a certain library, so that it becomes a de-facto standard. To achieve this, non-free programs must be allowed to use the library. A more frequent case is that a free library does the same job as widely used non-free libraries. In this case, there is little to be gained by limiting the free library to free software only, so we use the Lesser General Public License.

In other cases, permission to use a particular library in non-free programs enables a greater number of people to use a large body of free software. For example, permission to use the GNU C Library in non-free programs enables many more people to use the whole GNU operating system, as well as its variant, the GNU Linux operating system.

Although the Lesser General Public License is Less protective of the users' freedom, it does ensure that the user of a program that is linked with the Library has the freedom and the wherewithal to run that program using a modified version of the Library.

The precise terms and conditions for copying, distribution and modification follow. Pay close attention to the difference between a "work based on the library" and a "work that uses the library". The former contains code derived from the library, whereas the latter must be combined with the library in order to run.

### TERMS AND CONDITIONS FOR COPYING, DISTRIBUTION AND MODIFICATION

0. This License Agreement applies to any software library or other program which contains a notice placed by the copyright holder or other authorized party saying it may be distributed under the terms of this Lesser General Public License (also called "this License"). Each licensee is addressed as "you".

A "library" means a collection of software functions and/or data prepared so as to be conveniently linked with application programs (which use some of those functions and data) to form executables.

The "Library", below, refers to any such software library or work which has been distributed under these terms. A "work based on the Library" means either the Library or any derivative work under copyright law: that is to say, a work containing the Library or a portion of it, either verbatim or with modifications and/or translated straightforwardly into another language. (Hereinafter, translation is included without limitation in the term "modification".)

"Source code" for a work means the preferred form of the work for making modifications to it. For a library, complete source code means all the source code for all modules it contains, plus any associated interface definition files, plus the scripts used to control compilation and installation of the library.

Activities other than copying, distribution and modification are not covered by this License; they are outside its scope. The act of running a program using the Library is not restricted, and output from such a program is covered only if its contents constitute a work based on the Library (independent of the use of the Library in a tool for writing it). Whether that is true depends on what the Library does and what the program that uses the Library does.

1. You may copy and distribute verbatim copies of the Library's complete source code as you receive it, in any medium, provided that you conspicuously and appropriately publish on each copy an appropriate copyright notice and disclaimer of warranty; keep intact all the notices that refer to this License and to the absence of any warranty; and distribute a copy of this License along with the Library.

You may charge a fee for the physical act of transferring a copy, and you may at your option offer warranty protection in exchange for a fee.

2. You may modify your copy or copies of the Library or any portion of it, thus forming a work based on the Library, and copy and distribute such modifications or work under the terms of Section 1 above, provided that you also meet all of these conditions:

- The modified work must itself be a software library.
- You must cause the files modified to carry prominent notices stating that you changed the files and the date of any change.
- You must cause the whole of the work to be licensed at no charge to all third parties under the terms of this License.
- If a facility in the modified Library refers to a function or a table of data to be supplied by an application program that uses the facility, other than as an argument passed when the facility is invoked, then you must make a good faith effort to ensure that, in the event an application does not supply such function or table, the facility still operates, and performs whatever part of its purpose remains meaningful. (For example, a function in a library to compute square roots has a purpose that is entirely well-defined independent of the application. Therefore, Subsection 2d requires that any application-supplied function or table used by this function must be optional: if the application does not supply it, the square root function must still compute square roots.)

These requirements apply to the modified work as a whole. If identifiable sections of that work are not derived from the Library, and can be reasonably considered independent and separate works in themselves, then this License, and its terms, do not apply to those sections when you distribute them as separate works. But when you distribute the same sections as part of a whole which is a work based on the Library, the distribution of the whole must be on the terms of this License, whose permissions for other licenses extend to the entire whole, and thus to each and every part regardless of who wrote it.

Thus, it is not the intent of this section to claim rights or contest your rights to work written entirely by you; rather, the intent is to exercise the right to control the distribution of derivative or collective works based on the Library.

In addition, mere aggregation of another work not based on the Library with the Library (or with a work based on the Library) on a volume of a storage or distribution medium does not bring the other work under the scope of this License.

- You may opt to apply the terms of the ordinary GNU General Public License instead of this License to a given copy of the Library. To do this, you must alter all the notices that refer to this License, so that they refer to the ordinary GNU General Public License, version 2, instead of to this License. (If a newer version than version 2 of the ordinary GNU General Public License has appeared, then you can specify that version instead if you wish.) Do not make any other change in these notices. Once this change is made in a given copy, it is irreversible for that copy, so the ordinary GNU General Public License applies to all subsequent copies and derivative works made from that copy. This option is useful when you wish to copy part of the code of the Library into a program that is not a library.
- You may copy and distribute the Library (or a portion or derivative of it, under Section 2) in object code or executable form under the terms of Sections 1 and 2 above provided that you accompany it with the complete corresponding machine-readable source code, which must be distributed under the terms of Sections 1 and 2 above on a medium customarily used for software interchange. If distribution of object code is made by offering access to copy from a designated place, then offering equivalent access to copy the source code from the same place satisfies the requirement to distribute the source code, even though third parties are not compelled to copy the source along with the object code.
- A program that contains no derivative of any portion of the Library, but is designed to work with the Library by being compiled or linked with it, is called a "work that uses the Library". Such a work, in isolation, is not a derivative work of the Library, and therefore falls outside the scope of this License. However, linking a "work that uses the Library" with the Library creates an executable that is a derivative of the Library (because it contains portions of the Library), rather than a "work that uses the Library". The executable is therefore covered by this License. Section 6 states terms for distribution of such executables. When a "work that uses the Library" uses material from a header file that is part of the Library, the object code for the work may be a derivative work of the Library even

though the source code is not. Whether this is true is especially significant if the work can be linked without the Library, or if the work is itself a library. The threshold for this to be true is not precisely defined by law. If such an object file uses only numerical parameters, data structure layouts and accessors, and small macros and small inline functions (ten lines or less in length), then the use of the object file is unrestricted, regardless of whether it is legally a derivative work. (Executables containing this object code plus portions of the Library will still fall under Section 6.)

Otherwise, if the work is a derivative of the Library, you may distribute the object code for the work under the terms of Section 6. Any executables containing that work also fall under Section 6, whether or not they are linked directly with the Library itself.

6. As an exception to the Sections above, you may also combine or link a "work that uses the Library" with the Library to produce a work containing portions of the Library, and distribute that work under terms of your choice, provided that the terms permit modification of the work for the customer's own use and reverse engineering for debugging such modifications.

You must give prominent notice with each copy of the work that the Library is used in it and that the Library and its use are covered by this License. You must supply a copy of this License. If the work during execution displays copyright notices, you must include the copyright notice for the Library among them, as well as a reference directing the user to the copy of this License. Also, you must do one of these things:

- Accompany the work with the complete corresponding machine-readable source code for the Library (which must be distributed under Sections 1 and 2 above); and, if the work is an executable linked with the Library, with the complete machine-readable "work that uses the Library", as object code and/or source code, so that the user can modify the Library and then relink to produce a modified executable containing the modified Library. (It is understood that the user who changes the contents of definitions files in the Library will not necessarily be able to recompile the application to use the modified definitions.)
- Use a suitable shared library mechanism for linking with the Library. A suitable mechanism is one that (1) uses at run time a copy of the library already present on the user's computer system, rather than copying library functions into the executable, and (2) will operate properly with a modified version of the library, if the user installs one, as long as the modified version is interface-compatible with the version that the work was made with.
- Accompany the work with a written offer, valid for at least three years, to give the same user the materials specified in Subsection 6a, above, for a charge no more than the cost of performing this distribution.
- If distribution of the work is made by offering access to copy from a designated place, offer equivalent access to copy the above specified materials from the same place.
- Verify that the user has already received a copy of these materials or that you have already sent this user a copy.

For an executable, the required form of the "work that uses the Library" must include any data and utility programs needed for reproducing the executable from it. However, as a special exception, the materials to be distributed need not include anything that is normally distributed (in either source or binary form) with the major components (compiler, kernel, and so on) of the operating system on which the executable runs, unless that component itself accompanies the executable. It may happen that this requirement contradicts the license restrictions of other proprietary libraries that do not normally accompany the operating system. Such a contradiction means you cannot use both them and the Library together in an executable that you distribute.

- You may place library facilities that are a work based on the Library side-by-side in a single library together with other library facilities not covered by this License, and distribute such a combined library, provided that the separate distribution of the work based on the Library and of the other library facilities is otherwise permitted, and provided that you do these two things:
  - Accompany the combined library with a copy of the same work based on the Library, uncombined with any other library facilities. This must be distributed under the terms of the Sections above.
  - Give prominent notice with the combined library of the fact that part of it is a work based on the Library, and explaining where to find the accompanying uncombined form of the same work.
- You may not copy, modify, sublicense, link with, or distribute the Library except as expressly provided under this License. Any attempt otherwise to copy, modify,

sublicense, link with, or distribute the Library is void, and will automatically terminate your rights under this License. However, parties who have received copies, or rights, from you under this License will not have their licenses terminated so long as such parties remain in full compliance.

- You are not required to accept this License, since you have not signed it. However, nothing else grants you permission to modify or distribute the Library or its derivative works. These actions are prohibited by law if you do not accept this License. Therefore, by modifying or distributing the Library (or any work based on the Library), you indicate your acceptance of this License to do so, and all its terms and conditions for copying, distributing or modifying the Library or works based on it.
- Each time you redistribute the Library (or any work based on the Library), the recipient automatically receives a license from the original licensor to copy, distribute, link with or modify the Library subject to these terms and conditions. You may not impose any further restrictions on the recipients' exercise of the rights granted herein. You are not responsible for enforcing compliance by third parties with this License.

11. If, as a consequence of a court judgment or allegation of patent infringement or for any other reason (not limited to patent issues), conditions are imposed on you (whether by court order, agreement or otherwise) that contradict the conditions of this License, they do not excuse you from the conditions of this License. If you cannot distribute so as to satisfy simultaneously your obligations under this License and any other pertinent obligations, then as a consequence you may not distribute the Library at all. For example, if a patent license would not permit royalty-free redistribution of the Library by all those who receive copies directly or indirectly through you, then the only way you could satisfy both it and this License would be to refrain entirely from distribution of the Library. If any portion of this section is held invalid or unenforceable under any particular circumstance, the balance of the section is intended to apply, and the section as a whole is intended to apply in other circumstances.

It is not the purpose of this section to induce you to infringe any patents or other property right claims or to contest validity of any such claims; this section has the sole purpose of protecting the integrity of the free software distribution system which is implemented by public license practices. Many people have made generous contributions to the wide range of software distributed through that system in reliance on consistent application of that system; it is up to the author donor to decide if he or she is willing to distribute software through any other system and a licensee cannot impose that choice.

This section is intended to make thoroughly clear what is believed to be a consequence of the rest of this License.

- If the distribution and/or use of the Library is restricted in certain countries either by patents or by copyrighted interfaces, the original copyright holder who places the Library under this License may add an explicit geographical distribution limitation excluding those countries, so that distribution is permitted only in or among countries not thus excluded. In such case, this License incorporates the limitation as if written in the body of this License.
- The Free Software Foundation may publish revised and/or new versions of the Lesser General Public License from time to time. Such new versions will be similar in spirit to the present version, but may differ in detail to address new problems or concerns.

Each version is given a distinguishing version number. If the Library specifies a version number of this License which applies to it and "any later version", you have the option of following the terms and conditions either of that version or of any later version published by the Free Software Foundation. If the Library does not specify a license version number, you may choose any version ever published by the Free Software Foundation.

- If you wish to incorporate parts of the Library into other free programs whose distribution conditions are incompatible with these, write to the author to ask for permission. For software which is copyrighted by the Free Software Foundation, write to the Free Software Foundation; we sometimes make exceptions for this. Our decision will be guided by the two goals of preserving the free status of all derivatives of our free software and of promoting the sharing and reuse of software generally.

#### NO WARRANTY

15. BECAUSE THE LIBRARY IS LICENSED FREE OF CHARGE, THERE IS NO WARRANTY FOR THE LIBRARY, TO THE EXTENT PERMITTED BY APPLICABLE LAW. EXCEPT WHEN OTHERWISE STATED IN WRITING THE COPYRIGHT HOLDERS AND/OR OTHER PARTIES PROVIDE THE LIBRARY "AS IS" WITHOUT WARRANTY OF ANY KIND, EITHER EXPRESSED OR IMPLIED, INCLUDING, BUT NOT LIMITED TO, THE IMPLIED

WARRANTIES OF MERCHANTABILITY AND FITNESS FOR A PARTICULAR PURPOSE. THE ENTIRE RISK AS TO THE QUALITY AND PERFORMANCE OF THE LIBRARY IS WITH YOU. SHOULD THE LIBRARY PROVE DEFECTIVE, YOU ASSUME THE COST OF ALL NECESSARY SERVICING, REPAIR OR CORRECTION.

- IN NO EVENT UNLESS REQUIRED BY APPLICABLE LAW OR AGREED TO IN WRITING WILL ANY COPYRIGHT HOLDER, OR ANY OTHER PARTY WHO MAY MODIFY AND/OR REDISTRIBUTE THE LIBRARY AS PERMITTED ABOVE, BE LIABLE TO YOU FOR DAMAGES, INCLUDING ANY GENERAL, SPECIAL, INCIDENTAL OR CONSEQUENTIAL DAMAGES ARISING OUT OF THE USE OR INABILITY TO USE THE LIBRARY (INCLUDING BUT NOT LIMITED TO LOSS OF DATA OR DATA BEING RENDERED INACCURATE OR LOSSES SUSTAINED BY YOU OR THIRD PARTIES OR A FAILURE OF THE LIBRARY TO OPERATE WITH ANY OTHER SOFTWARE), EVEN IF SUCH HOLDER OR OTHER PARTY HAS BEEN ADVISED OF THE POSSIBILITY OF SUCH DAMAGES.

#### END OF TERMS AND CONDITIONS

##### How to Apply These Terms to Your Libraries

If you develop a new library, and you want it to be of the greatest possible use to the public, we recommend making it free software that everyone can redistribute and change. You can do so by permitting redistribution under these terms (or, alternatively, under the terms of the ordinary General Public License).

To apply these terms, attach the following notices to the library. It is safest to attach them to the start of each source file to most effectively convey the exclusion of warranty; and each file should have at least the "copyright" line and a pointer to where the full notice is found.

>one line to give the library's name and a brief idea of what it does.>

Copyright © <year> <name of author>

This library is free software; you can redistribute it and/or modify it under the terms of the GNU Lesser General Public License as published by the Free Software Foundation; either version 2.1 of the License, or (at your option) any later version.

This library is distributed in the hope that it will be useful, but WITHOUT ANY WARRANTY; without even the implied warranty of MERCHANTABILITY or FITNESS FOR A PARTICULAR PURPOSE. See the GNU Lesser General Public License for more details.

You should have received a copy of the GNU Lesser General Public License along with this library; if not, write to the Free Software Foundation, Inc., 51 Franklin Street, Fifth Floor, Boston, MA 02110-1301 USA

Also add information on how to contact you by electronic and paper mail.

You should also get your employer (if you work as a programmer) or your school, if any, to sign a "copyright disclaimer" for the library, if necessary. Here is a sample; alter the names:

Yoodyne, Inc., hereby disclaims all copyright interest in the library 'Frob' (a library for tweaking knobs) written by James Random Hacker.

<signature of Ty Coon>, 1 April 1990

Ty Coon, President of Vice

That's all there is to it!

#### ◆[Notice on GNU General Public License]

This product include the software licensed for use under the terms of a GNU General Public License. A copy of the corresponding source code can be obtained by being charged the fee for distribution.

To obtain a copy, contact your local Pioneer Customer Support Center.

See the GNU website (<http://www.gnu.org>) for details of the GNU General Public License.

# Troubleshooting

Incorrect operation is often mistaken for trouble or malfunction. If you think that there is something wrong with this component, check the points below. Sometimes the trouble may lie in another component. Inspect the other components and electrical appliances being used. If the trouble cannot be rectified after checking the items below, please contact customer services. In the US, call Toll Free (800) 421-1404. (Telephone lines are open Monday through Friday 6:00 AM to 4:30 PM (Pacific Time).) In Canada, call Local (905) 479-4411, or Long distance +1(877) 283-5901. (Telephone lines are open Monday through Friday 9:00 AM to 5:30 PM (EST).)

## Playback

Problem	Check	Remedy
<ul style="list-style-type: none"> <li>• Disc does not play.</li> <li>• Disc tray opens automatically.</li> </ul>	Is the disc one that is playable on this player?	Check whether the disc is one that can be played on this player (page 8).
	Is the file one that is playable on this player?	<ul style="list-style-type: none"> <li>• Check whether the file is one that can be played on this player (page 10).</li> <li>• Check whether or not the file is damaged.</li> </ul>
	Is the disc scratched?	It may not be possible to play scratched discs.
	Is the disc dirty?	Clean the disc (page 15).
	Is there a piece of paper or sticker attached to the disc?	The disc may be warped and unplayable.
	Is the disc properly set in the disc tray?	<ul style="list-style-type: none"> <li>• Set the disc with the printed side facing up.</li> <li>• Set the disc properly in the depression in the disc tray.</li> </ul>
	Is the region number correct?	See <i>About region numbers</i> on page 10 for the region numbers of discs that can be played on this player.
No picture is displayed or the picture is not displayed properly.	Is the video cable properly connected?	<ul style="list-style-type: none"> <li>• Connect the cable properly according to the connected devices (page 18).</li> <li>• Insert the cable firmly and all the way in.</li> </ul>
	Is the video cable damaged?	If the cable is damaged, replace it with a new one.
	Is the input setting on the connected TV or AV receiver or amplifier right?	Read the operating instructions of the connected components and switch to the proper input.
	Are you viewing the picture from the video output terminal selected with <b>VIDEO SELECT</b> ?	Press <b>VIDEO SELECT</b> to switch the video output terminal to be viewed (page 26).
	Is the output video resolution properly set?	Use <b>OUTPUT RESOLUTION</b> to switch to a resolution at which the video and audio signals are output (page 27).
	<ul style="list-style-type: none"> <li>• Is the player connected with an HDMI cable other than a High Speed HDMI™ cable (with a Standard HDMI™ cable)?</li> <li>• Are you using an HDMI cable with built-in equalizer?</li> </ul>	1080p or Deep Color video signals may not be output properly, depending on the HDMI cable being used or the player's settings. Press <b>■</b> while pressing <b>▶</b> on the player's front panel to restore the video outputs to the factory default settings. After this, if you wish to output the video signals with 1080p or Deep Color, connect the TV using a High Speed HDMI™ cable without built-in equalizer, then reset the player using the <b>Setup Navigator</b> (page 23).
	Does the connected TV support the frame rate of the video signal being output by the player?	If the picture is not displayed when playing a disc with a frame rate that is not supported, the picture will not be displayed even when playback is stopped. In this case, use the procedure below to switch the frame rate of the video signals output from the player. Eject the disc and close the disc tray. Then, press <b>▲ OPEN/CLOSE</b> while pressing <b>▶</b> on the player's front panel to switch to a frame rate supported by the connected TV.
	Is a DVI device connected?	The picture may not be displayed properly if a DVI device is connected.
	Is <b>NTSC on PAL TV</b> properly set?	When viewing the video signals output from the player's Video terminal, set <b>NTSC on PAL TV</b> properly (page 43).
	Is <b>HDMI Color Space</b> properly set?	Change the <b>HDMI Color Space</b> setting (page 44).

Problem	Check	Remedy
No picture is displayed or the picture is not displayed properly.	Are you using an extremely long cable?	Using an extremely long cable may result in noise. Use a relatively short cable.
Picture freezes and the front panel and remote control buttons stop working.		<ul style="list-style-type: none"> <li>• Press <b>■ STOP</b> to stop playback, then restart playback.</li> <li>• If the playback cannot be stopped, press <b>⏻ STANDBY/ON</b> on the player's front panel to turn off the power, then turn the power back on.</li> <li>• If the power cannot be turned off, press and hold <b>⏻ STANDBY/ON</b> on the player's front panel for over 5 seconds. The power will turn off.</li> </ul>
Motion is unnatural or picture is not clear.		Change the <b>Pure Cinema</b> setting (page 39).
No picture is displayed or picture is not output in high definition when playing BDs.		With some discs, it may not be possible to output the video signals from the <b>VIDEO</b> output terminal or the <b>COMPONENT VIDEO</b> output terminals. In this case, connect using an HDMI cable (page 18).
<ul style="list-style-type: none"> <li>• Picture is disturbed during playback.</li> <li>• Picture is dark.</li> </ul>		<ul style="list-style-type: none"> <li>• This player supports Macrovision analog copy protection technology. With some TVs (such as with built-in video deck), the picture will not be displayed properly when the copy protected DVD title is played. This is not a malfunction.</li> <li>• If the player and TV are connected via a DVD recorder/video deck, etc., the picture will not be displayed properly due to analog copy protection. Connect the player and TV directly.</li> </ul>
<ul style="list-style-type: none"> <li>• Picture is stretched.</li> <li>• Picture is cropped.</li> <li>• Aspect ratio cannot be switched.</li> </ul>	Is the TV's aspect ratio properly set?	Read the TV's operating instructions and set the TV's aspect ratio properly.
	Is <b>TV Aspect Ratio</b> properly set?	Set <b>TV Aspect Ratio</b> properly (page 42).
	Is <b>4:3 Video Out</b> properly set?	Set <b>4:3 Video Out</b> properly (page 42).
	Is <b>DVD 16:9 Video Out</b> properly set?	Set <b>DVD 16:9 Video Out</b> properly (page 42).
		When video signals with a resolution of 1080/60i, 1080/60p, 720/60p, 1080/24p, 1080/50i, 1080/50p or 720/50p are being output from the <b>HDMI OUT</b> terminal or the <b>COMPONENT VIDEO</b> output terminals, they may be output with an aspect ratio of 16:9 even if <b>TV Aspect Ratio</b> is set to <b>4:3 (Standard)</b> (page 42).
Picture is interrupted.		The picture may be interrupted when the resolution of the recorded video signal switches. Press <b>OUTPUT RESOLUTION</b> to select a setting other than <b>Auto</b> or <b>Source Direct</b> (page 27).
The subtitles cannot be switched.		The subtitles cannot be switched for discs recorded on a DVD or BD recorder.
Sound and picture are not synchronized.	Is <b>Output Terminal</b> properly set?	Set <b>Output Terminal</b> properly (pages 23 and 51).
	Is <b>Lip Sync</b> properly set?	Adjust the amount of audio delay with the <b>Lip Sync</b> setting (page 41).
<ul style="list-style-type: none"> <li>• No sound is output.</li> <li>• Sound is not output properly.</li> </ul>	Is the disc played back in slow motion?	No sound is output during slow motion play and forward and reverse scanning.
	Is the disc played back in fast forward or fast reverse?	
	Are the audio cables properly connected?	<ul style="list-style-type: none"> <li>• Connect the cable properly according to the connected devices (page 18).</li> <li>• Insert the cable firmly and all the way in.</li> </ul>
	Is the audio cable damaged?	If the cable is damaged, replace it with a new one.
	Are the connected components (AV receiver or amplifier, etc.) properly set?	Read the operating instructions of the connected components and check the volume, input, speaker settings, etc.

Problem	Check	Remedy
<ul style="list-style-type: none"> <li>No sound is output.</li> <li>Sound is not output properly.</li> </ul>	Are you trying to listen to the sound of the <b>HDMI OUT</b> terminal while watching the picture from the <b>COMPONENT VIDEO</b> or <b>VIDEO</b> output terminals?	Audio signals are not output from the <b>HDMI OUT</b> terminal when video signals are being output from the <b>COMPONENT VIDEO</b> or <b>VIDEO</b> output terminals. When watching the picture of the <b>COMPONENT VIDEO</b> or <b>VIDEO</b> output terminals, connect an optical digital audio cable or regular audio cables to listen to the sound (page 21). Once connections are completed, use <b>Setup Navigator</b> to make the player's settings (page 23).
	Is <b>HDMI Audio Out</b> properly set?	Set <b>HDMI Audio Out</b> to <b>Auto</b> or <b>PCM</b> . (page 44).
	Is <b>Output Terminal</b> properly set?	When <b>ANALOG AUDIO</b> is selected at <b>Output Terminal</b> , no audio signals are output from the <b>HDMI OUT</b> or <b>DIGITAL OUT</b> terminal (page 51).
	Is the output video resolution properly set?	Use <b>OUTPUT RESOLUTION</b> to switch to the resolution at which the video and audio signals are output (page 27).
	Is the AV receiver or amplifier, etc., connected to the <b>AUDIO OUT</b> terminals?	To listen to 2-channel analog audio, connect to <b>FRONT (L/R)</b> of the <b>AUDIO OUT</b> terminals (page 13) and set <b>Audio Output Mode</b> to <b>2 Channel</b> (page 43).
	Are the speakers properly set?	When the AV receiver or amplifier, etc., is connected to the <b>AUDIO OUT</b> terminals and <b>Audio Output Mode</b> is set to <b>Multi-channel</b> , set <b>Speaker Setup</b> properly (page 47).
Multi-channel sound is not output.	Is <b>Output Terminal</b> properly set?	Linear PCM (2-channel) audio signals are output from output terminals other than the one set at <b>Output Terminal</b> under <b>Audio Out</b> . Set <b>Output Terminal</b> properly (page 51).
	Is the audio output of the connected AV receiver or amplifier, etc., properly set?	Read the operating instructions of the connected AV receiver or amplifier and check the audio output settings of AV receiver or amplifier.
	Is multi-channel sound selected?	Use the menu screen or <b>AUDIO</b> to switch the disc's sound to multi-channel.
	Is the AV receiver or amplifier, etc., connected to the <b>AUDIO OUT</b> terminals?	When the AV receiver or amplifier, etc., is connected to the <b>AUDIO OUT</b> terminals, set <b>Audio Output Mode</b> to <b>Multi-channel</b> (page 43). Also, set <b>Speaker Setup</b> properly (page 47).
Noise can be heard when outputting DTS Digital Surround signals from the <b>DIGITAL OUT</b> terminal.	Is the connected AV receiver or amplifier compatible with DTS Digital Surround?	If an AV receiver or amplifier that is not compatible with DTS Digital Surround is connected to the <b>DIGITAL OUT</b> terminal, set <b>DTS Out</b> to <b>DTS → PCM</b> (page 43).
192 kHz or 96 kHz digital audio signals cannot be output from the <b>DIGITAL OUT</b> terminal.		It is not possible to output 192 kHz or 96 kHz digital audio signals from this player's <b>DIGITAL OUT</b> terminal. The signals are automatically converted to 48 kHz or less for output.
Secondary audio or interactive audio is not output.	Is <b>HDMI Audio Out</b> properly set?	When listening to the sound from an <b>HDMI OUT</b> terminal, set <b>HDMI Audio Out</b> to <b>PCM</b> (page 44).
	Are <b>Dolby Digital Out</b> and <b>DTS Out</b> properly set?	When listening to the sound from an <b>DIGITAL OUT</b> terminal, set <b>Dolby Digital Out</b> to <b>Dolby Digital 1</b> , <b>DTS Out</b> to <b>DTS 1</b> (page 43).
Sound is fast or slow.	When an HDMI cable is connected, are audio signals being output from devices connected with cables other than HDMI cables?	When a Pioneer AV receiver or amplifier compatible with the PQLS function is connected directly to the player's <b>HDMI OUT</b> terminal using an HDMI cable, the PQLS function is activated when playing discs. Because of this, the sound output from components other than the ones connected by HDMI cable may be fast or slow. If this happens, set <b>PQLS</b> to <b>Off</b> (page 44).
After a disc is inserted, <b>Loading</b> stays displayed and playback does not start.	Are there too many files recorded on the disc?	When a disc on which files are recorded is inserted, depending on the number of files recorded on the disc, loading may take several dozen minutes.
■ is displayed in file names, etc.		The characters that cannot be displayed on this player are displayed in ■.

Problem	Check	Remedy
A message indicating low memory appears while playing a BD-ROM disc.		<ul style="list-style-type: none"> <li>Perform <b>Individual/Shared Data Erase</b> or <b>Storage Format</b> (page 49).</li> <li>Perform <b>Application Data Erase</b> (page 49).</li> </ul>
The DVD layer of BD and DVD hybrid discs cannot be played.	Is <b>Hybrid Disc Playback</b> properly set?	Set <b>Hybrid Disc Playback</b> to <b>DVD</b> (page 45).
The CD layer of BD and CD hybrid discs cannot be played.	Is <b>Hybrid Disc Playback</b> properly set?	Set <b>Hybrid Disc Playback</b> to <b>CD</b> (page 45).
The BDMV format on BD-R/-RE discs cannot be played.		To play the BDMV format on BD-R/-RE discs containing both BDMV and BDAV formats, set <b>BDMV/BDAV Playback Priority</b> to <b>BDMV</b> (page 45).
The player does not play in the order registered on the playlist.	Are you using a commercially available disc for the playlist playback?	When a commercially available disc is used, the player may not play in the order registered on the playlist. To play a playlist, use a disc created specifically for this player, not commercially available discs.

## KURO LINK

Problem	Check	Remedy
KURO LINK function does not work.	Is the HDMI cable properly connected?	To use the KURO LINK function, connect the Flat Panel TV and AV system (AV receiver or amplifier, etc.) to the <b>HDMI OUT</b> terminal (page 20).
	Is the HDMI cable you are using a High Speed HDMI™ cable?	Use a High Speed HDMI™ cable. The KURO LINK function may not work properly if HDMI cable other than a High Speed HDMI™ cable is used.
	Are you connected to the TV using an HDMI cable to watch the picture?	If video signals are being output from a terminal other than the <b>HDMI OUT</b> terminal, the KURO LINK function does not work. Connect to the TV using an HDMI cable and press <b>VIDEO SELECT</b> to switch to the <b>HDMI OUT</b> terminal (pages 20 and 26).
	Is <b>KURO LINK</b> set to <b>On</b> on the player?	Set <b>KURO LINK</b> to <b>On</b> on the player (page 44).
	Does the connected device support the KURO LINK function?	<ul style="list-style-type: none"> <li>The KURO LINK function will not work with devices of other brands that do not support the KURO LINK function, even when connected using an HDMI cable.</li> <li>The KURO LINK function will not work if devices that do not support the KURO LINK function are connected between the KURO LINK-compatible device and the player.</li> <li>See <i>About connections to components of other makes supporting the KURO LINK function</i> on page 20.</li> <li>Even when connected to a Pioneer product compatible with the KURO LINK function, some of the functions may not work.</li> </ul> <p>Also refer to the operating instructions of the connected device.</p>
	Is KURO LINK set to On on the connected device?	Set KURO LINK to On on the connected device. The KURO LINK function operates when KURO LINK is set to On for all devices connected to the <b>HDMI OUT</b> terminal. Once connections and settings of all the devices are finished, be sure to check that the player's picture is output to the Flat Panel TV. (Also check after changing the connected devices and connecting and/or disconnecting HDMI cables.) If the player's picture is not being output to the Flat Panel TV, the KURO LINK function may not work properly. For details, refer to the operating instructions of the connected device.
Are multiple players connected?	The KURO LINK function may not work if three or more players, including this player, are connected by HDMI cable.	

Problem	Check	Remedy
The input does not switch automatically on the Flat Panel TV and AV system (AV receiver or amplifier, etc.) when playback is started on the player or the Home Menu or Home Media Gallery is displayed.	Is <b>Display Power On</b> set to <b>Off</b> on the player?	Set <b>Display Power On</b> to <b>On</b> (page 44).

## Network

Problem	Check	Remedy
<ul style="list-style-type: none"> <li>BD-LIVE function (connection to the Internet) cannot be used.</li> <li>"Connection to the software updating server failed" is displayed when you try to update the software.</li> </ul>		Perform <b>Connection Test</b> (page 49). If "Network connection test completed successfully." is displayed, check the proxy server settings (page 48). Also there may be a problem with the Internet connection. Contact your Internet service provider.
"OK to grant network access to BD applications?" is displayed when a BD-LIVE compatible disc is read.		<ul style="list-style-type: none"> <li>This is displayed for discs presenting security risks related to connection to the Internet. Normally select <b>No</b> when this is displayed. To allow connection to the Internet, select <b>Yes</b>.</li> <li>This may be displayed even if the disc does not support the BD-Live function.</li> </ul>
Software updating is slow.		Depending on the Internet connection and other conditions, some time may be required to update the software.
The player stops operating while software is being updated.		Software updating takes 10 to 20 minutes. Wait until updating is completed. DO NOT turn the power off while the software is being updated. Doing so may result in an operation failure.
<ul style="list-style-type: none"> <li>"WRT NG ****" is displayed on the front panel display during software updating. (**** meaning any characters)</li> <li>"WRT FAILED" is displayed on the front panel display during software updating.</li> </ul>		The message is displayed when software updating has failed. Check again whether it can be updated properly.
A message other than "Network connection test completed successfully" is displayed when <b>Connection Test</b> is performed.	<p>Is "LAN cable not connected" displayed?</p> <ul style="list-style-type: none"> <li>Is "IP address cannot be obtained." displayed?</li> <li>Is "No response from the gateway." displayed?</li> </ul> <p>Is "IP address is overlapped." displayed?</p> <p>Is the Ethernet hub (or router with hub functionality) operating properly?</p>	<p>Check that this player and Ethernet hub (or router with hub functionality) are properly connected.</p> <ul style="list-style-type: none"> <li>If the IP address is obtained using the DHCP server function, check the setting is correct at the <b>Display Network Configuration</b> (page 49). For details on the DHCP server function, see the operating instructions of the Ethernet hub (or router with hub functionality).</li> <li>Set the IP address manually.</li> <li>Check the operation and settings of the DHCP server function of the Ethernet hub (or router with hub functionality). For details on the DHCP server function, see the operating instructions of the Ethernet hub (or router with hub functionality).</li> <li>If this player's has been set manually, reset the IP address of this player or other components.</li> <li>Check the settings and operation the Ethernet hub (or router with hub functionality). For details, see the operating instructions of the Ethernet hub.</li> <li>Reboot the Ethernet hub (or router with hub functionality).</li> </ul>

Problem	Check	Remedy
Player cannot be restored to the factory defaults.	Is a disc loaded in the player?	Remove the disc from the player before restoring the player to the factory defaults (page 51).
Player cannot be controlled by RS-232C.		Check the <b>Advanced Setup → Baud Rate</b> setting and the serial interface specifications (page 56 and 58).
The player's power turns off automatically.	Is <b>Auto Power Off</b> set to <b>On</b> ?	If <b>Auto Power Off</b> is set to <b>On</b> , the player's power turns off automatically if no operation is performed for over 30 minutes (page 46).
	Is <b>Display Power Off</b> set to <b>On</b> ?	The player's power may turn off together with the power of the TV connected to the <b>HDMI OUT</b> terminal. If you do not want the player's power to turn off when the TV's power is turned off, set <b>Display Power Off</b> to <b>Off</b> (page 44).
The player's power turns on automatically.	Is <b>KURO LINK</b> set to <b>On</b> ?	The player's power may turn on together with the power of the TV connected to the <b>HDMI OUT</b> terminal. If you do not want the player's power to turn on when the TV's power is turned on, set <b>KURO LINK</b> to <b>Off</b> (page 44).
Player cannot be operated with remote control.	Is an AV receiver or amplifier connected to the <b>CONTROL IN</b> terminal on the player's rear panel?	Operate with the remote control of the device connected to the <b>CONTROL IN</b> terminal.
	Are you operating the remote control from a point too far away from the player?	Operate from within 23 feet (7 m) of the remote control sensor.
	Are the batteries dead?	Replace the batteries (page 7).
	Is the RC-232C Key Lock command set?	Cancel the Key Lock command. For details, see the communications interface user's manual.
Black screen is displayed though no operations are being performed.	Is <b>Screen Saver</b> set to <b>On</b> ?	<ul style="list-style-type: none"> <li>The screensaver turns off when the player's front panel or remote control is operated.</li> <li>If you do not want the screensaver to be activated, set <b>Screen Saver</b> to <b>Off</b> (page 46).</li> </ul>
Front panel display does not turn on.	Has the front panel display been turned off?	Press <b>FL DIMMER</b> on the remote control to switch the front panel display's brightness (page 12).
Buttons on the player's front panel cannot be operated or the disc tray does not open.	Is <b>Front Key Lock</b> set to <b>All</b> or <b>Tray</b> ?	Set <b>Front Key Lock</b> to <b>Off</b> (page 55).
Input of connected TV and AV system switches automatically.	Is <b>KURO LINK</b> set to <b>On</b> ?	The input of the TV and AV system (AV receiver or amplifier, etc.) connected to the <b>HDMI OUT</b> terminal may automatically switch to the player when playback starts on the player or the menu screen (Home Media Gallery, etc.) is displayed. If you do not want the inputs of the connected TV and AV system (AV receiver or amplifier, etc.) to switch automatically, set <b>KURO LINK</b> to <b>Off</b> (page 44).
"Processing failed." is displayed.		If the message appears repeatedly, please ask your nearest Pioneer authorized service center or your dealer to carry out repair work.
Settings you have made have been cleared.	<ul style="list-style-type: none"> <li>Have you disconnected the power cord while the player's power was on?</li> <li>Has there been a power failure?</li> </ul>	Always press <b>⏻ STANDBY/ON</b> on the player's front panel or <b>⏻ STANDBY/ON</b> on the remote control and check that <b>POWER OFF</b> has turned off from the player's front panel display before disconnecting the power cord. Be particularly careful when the power cord is connected to the AC outlet on another device because the player turns off in conjunction with the device.



Problem	Check	Remedy
<b>EXT</b> does not light on the player's front panel display when a USB (external storage) device is connected.	Is the external storage device properly connected?	<ul style="list-style-type: none"> <li>• Turn the player's power off, then turn the power back on.</li> <li>• Turn the player's power off, then reconnect the external storage device (page 21).</li> </ul>
	Are you using a USB cable that is longer than 2 meters?	Use a USB cable with a length of 2 meters or less.
	Is the power of the external hard disk turned on?	Turn the player's power off, then turn the external hard disk's power on.
	Is the external storage device connected to the <b>USB</b> port via a memory card reader or USB hub?	External storage device may not work if connected to the <b>USB</b> port via a memory card reader or USB hub.
	Does the external storage device contain multiple partitions?	External storage devices may not be recognized if they contain multiple partitions.  Some external storage devices may not operate.
<b>EXT</b> flashes on the player's front panel display when a USB (external storage) device is connected.	Is the external storage device write-protected?	Turn the player's power off, then disable the write-protection.
	Is the external storage device's file system FAT16 or FAT32?	Only external storage devices with a FAT16 or FAT32 file system can be used. They may be usable if they are formatted from the player (page 49).
		Turn the player's power off, then turn the power back on.

## Glossary

### ❖ Angle (Multi angle)

Up to 9 camera angles can be recorded simultaneously on BD-ROM or DVD-Video discs, letting you view the same scene from different angles.

### ❖ AVCHD (Advanced Video Codec High Definition)

See *Playing DVDs* on page 10.

### ❖ BDAV

Of the BD format, the Audio Visual Format Specifications for HD digital broadcast recording is referred to as BDAV on this player and in this operating instructions.

### ❖ BD-J

See *Playing BDs* on page 9.

### ❖ BD-LIVE

See *Playing BDs* on page 9.

### ❖ BDMV

Of the BD format, the Audio Visual Format Specifications designed for pre-packaged high definition (HD) movie contents is referred to as BDMV on this player and in this operating instructions.

### ❖ BONUSVIEW

See *Playing BDs* on page 9.

### ❖ Component video output

This video output terminal provides clearer pictures when connected to a TV equipped with component inputs. Component video signals consist of three signals, Y, PB and PR.

### ❖ Deep Color

See *About HDMI* on page 18.

### ❖ Default Gateway

A default gateway is a communication device such as a router which passes data between networks. It is used to direct data to networks on which the destination gateway is not explicitly specified.

### ❖ DHCP (Dynamic Host Configuration Protocol)

This protocol provides configuration parameters (IP address, etc.) for computers and other devices connected to the network.

### ❖ DNS (Domain Name System)

This is a system for associating Internet host names with IP addresses.

### ❖ Dolby Digital

Dolby Digital is an audio format to record the sound in up to 5.1 channels with a fraction of the amount of data as compared to linear PCM audio signals.

### ❖ Dolby Digital Plus

Dolby Digital Plus is an audio format for high-definition media. Built on Dolby Digital, it combines the efficiency and flexibility to provide high quality multi-channel audio. With BD-ROMs, up to 7.1 channels of digital sound can be recorded.

### ❖ Dolby TrueHD

Dolby TrueHD is an audio format using lossless coding. With BD-ROMs, up to 8 channels can be recorded at 96 kHz/24 bits, or up to 6 channels at 192 kHz/24 bits.

### ❖ DRM

A technology for protecting copyrighted digital data. Digitized videos, images and audio retain the same quality even when they are copied or transferred repeatedly. DRM is a technology for restricting the distribution or playback of such digital data without the authorization of the copyright holder.

### ❖ **DTS Digital Surround**

DTS Digital Surround is an audio format to record 48 kHz/24 bits audio signals in 5.1 channels.

### ❖ **DTS-HD High Resolution Audio**

DTS-HD High Resolution Audio is an audio format using lossy coding. It can record 7.1 channels at 96 kHz/24 bits.

### ❖ **DTS-HD Master Audio**

DTS-HD Master Audio is an audio format using lossless coding. With BD-ROMs, 7.1 channels can be recorded at 96 kHz/24 bits, or 5.1 channels at 192 kHz/24 bits.

### ❖ **Ethernet**

A standard for local area networks (LANs) used to connect multiple computers, etc. in the same location. This player supports 100BASE-TX.

### ❖ **Frames and fields**

A frame is the unit for one of the still pictures which compose motion pictures. One frame consists of a picture of odd lines and a picture of even lines called fields in video signal with interlaced scan method (480i, 1080i, etc.).

### ❖ **HDMI (High-Definition Multimedia Interface)**

See *About HDMI* on page 18.

### ❖ **Interactive audio**

The audio signals recorded in the titles of BD-ROMs. They include for example the clicking sound made when the menu screen is operated.

### ❖ **Interlaced scan**

With this method, one picture is displayed by scanning it twice. The odd lines are displayed in the first pass, the even lines are displayed in the second, to form a single picture (frame). Interlaced scan is indicated in this player and operating instructions by an "i" after the resolution value (for example, 480i).

### ❖ **IP address**

An address that identifies a computer or other device connected to the Internet or local area network. It is represented a number in four sections.

### ❖ **Linear PCM**

This is referred as the audio signals that are not compressed.

### ❖ **MAC (Media Access Control) address**

A hardware identification number assigned specifically to the network device (LAN card, etc.).

### ❖ **MPEG (Moving Picture Experts Group)**

The name of a family of standards used to encode video and audio signals in a digital compressed format. The video encoding standards include MPEG-1 Video, MPEG-2 Video, MPEG-4 Visual, MPEG-4 AVC, etc. The audio encoding standards include MPEG-1 Audio, MPEG-2 Audio, MPEG-2 AAC, etc.

### ❖ **Parental Lock**

See *Changing the Parental Lock level for viewing DVDs* and *Changing the Age Restriction for viewing BD-ROMs* on page 50.

### ❖ **Picture-in-Picture (P-in-P)**

This is a function for superimposing a sub video on the main video. Some BD-ROMs include secondary video, which can be superimposed on the primary video.

### ❖ **Port number**

This is a sub-address provided below the IP address for simultaneously connecting to multiple parties during Internet communications.

### ❖ **Progressive scan**

With this method, one picture is consisted of a single picture, without dividing it in two pictures. Progressive scan provides clear pictures with no flicker, in particular for still pictures that contain much text, graphics, or horizontal lines. Progressive scan is indicated in this player and operating instructions by a "p" after the resolution value (for example, 480p).

### ❖ **Proxy server**

This is a relay server for ensuring fast access and safe communications when connecting to the Internet from an internal network.

### ❖ **Region number**

See *About region numbers* on page 10.

### ❖ **Secondary audio**

Some BD-ROMs include sub audio streams mixed with the main audio stream. These sub audio streams are called "secondary audio". On some discs this secondary audio is recorded as the audio for the secondary video.

### ❖ **Secondary video**

Some BD-ROMs include sub videos superimposed on the main videos using the Picture-in-Picture function. These sub videos are called "secondary video".

### ❖ **Subnet mask**

This is used to identify which part of the IP address corresponds to the subnet (a separately managed network). The subnet mask is expressed as "255.255.255.0".

### ❖ **USB(Universal Serial Bus)**

USB is the industry standard for connecting peripherals to PCs.

### ❖ **VC-1**

A video codec developed by Microsoft and standardized by the Society of Motion Picture and Television Engineers (SMPTE). Some BDs include videos encoded in this codec.

### ❖ **x.v.Color**

See *About HDMI* on page 18.

# Specifications

<b>Model</b>		BDP-V6000	
<b>Type</b>		Blu-ray Disc PLAYER	
<b>Rated voltage</b>		AC 120 V	
<b>Rated frequency</b>		60 Hz	
<b>Power consumption</b>		32 W	
<b>Power consumption (standby)</b>		0.3 W	
<b>Inrush current</b>		26 A or less	
<b>Weight</b>		7 lb 12 oz (3.5 kg)	
<b>External dimensions (including projecting parts)</b>		16 <sup>9</sup> / <sub>16</sub> in. (W) x 3 in. (H) x 11 <sup>5</sup> / <sub>16</sub> in. (D) (420 mm (W) x 75 mm (H) x 287 mm (D))	
<b>Tolerable operating temperature</b>		+41 °F to +95 °F (+5 °C to +35 °C)	
<b>Tolerable operating humidity</b>		5 % to 85 % (no condensation)	
<b>Output terminals</b>	<b>HDMI</b>	1 set, 19-pin: 5 V, 250 mA	
	<b>Video outputs</b>	<b>Video</b>	1 set, RCA jack: 1.0 Vp-p (75 Ω)
		<b>Component video</b>	1 set, RCA jacks:
			Y: 1.0 Vp-p (75 Ω) PB, PR: 0.7 Vp-p (75 Ω)
	<b>Audio outputs</b>	<b>7.1-channel (multi-channel: front left/right, surround left/right, center, surround back left/right, subwoofer)</b>	1 set, Number of channels: 8, RCA jacks
		<b>Audio output level</b>	200 mVrms (1 kHz, -20 dB)
		<b>Frequency response</b>	4 Hz to 88 kHz (192 kHz sampling)
<b>Digital audio outputs</b>	<b>Optical</b>	1 set, Optical digital jack	
<b>LAN</b>		1 set, Ethernet jack (100BASE-TX)	
<b>Control</b>	<b>Input</b>	1 set, Minijack (3.5 ∅)	
<b>USB</b>		1 set, Type A	
<b>RS-232C</b>		1 set, D-sub 9-pin (male) connector conforming to RS-232C standards x 1 (inch screw threads)	



**Note**

- The specifications and design of this product are subject to change without notice.
- This product includes FontAvenue® fonts licenced by NEC Corporation. FontAvenue is a registered trademark of NEC Corporation.

Should this product require service in the U.S.A. and you wish to locate the nearest Pioneer Authorized Independent Service Company, or if you wish to purchase replacement parts, operating instructions, service manuals, or accessories, please call the number shown below.

1-800-872-4159

Please do not ship your product to Pioneer without first calling the Customer Support at the above listed number for assistance.

Pioneer Electronics (USA), INC.  
Service Support Division  
P.O. BOX 1760, Long Beach, CA 90801-1760, U.S.A.

For warranty information please see the Limited Warranty sheet included with your product.

Should this product require service in Canada, please contact a Pioneer Canadian Authorized Dealer to locate the nearest Pioneer Authorized Service Company in Canada. Alternatively, please contact the Customer Satisfaction Department at the following address:

Pioneer Electronics of Canada, Inc.  
Customer Satisfaction Department  
300 Allstate Parkway, Markham, Ontario L3R 0P2  
1-877-283-5901  
905-479-4411

For warranty information please see the Limited Warranty sheet included with your product.

Si ce produit doit être réparé au Canada, veuillez vous adresser à un distributeur autorisé Pioneer du Canada pour obtenir le nom du Centre de Service Autorisé Pioneer le plus près de chez-vous. Vous pouvez aussi contacter le Service à la clientèle de Pioneer:

Pioneer Électroniques du Canada, Inc.  
Service Clientèle  
300, Allstate Parkway, Markham, Ontario L3R 0P2  
1-877-283-5901  
905-479-4411

Pour obtenir des renseignements sur la garantie, veuillez vous reporter au feuillet sur la garantie restreinte qui accompagne le produit.

S021\_C\_EF

Published by Pioneer Corporation.  
Copyright © 2009 Pioneer Corporation.  
All rights reserved.

## **PIONEER CORPORATION**

4-1, Meguro 1-Chome, Meguro-ku, Tokyo 153-8654, Japan

### **PIONEER ELECTRONICS (USA) INC.**

P.O. BOX 1540, Long Beach, California 90801-1540, U.S.A. TEL: (800) 421-1404

### **PIONEER ELECTRONICS OF CANADA, INC.**

300 Allstate Parkway, Markham, Ontario L3R 0P2, Canada TEL: 1-877-283-5901, 905-479-4411